

Vacuum Hose Reel 881 Ex

ATEX approved vacuum hose reel suitable for cleaning explosive dust.



The vacuum hose reel 881 Ex facilitates the handling of long and heavy vacuum hoses, and provides tidy and safe storage when they are not in use. Keeps hoses out of the way of forklifts and mobile workshop equipment. Separate suspension brackets make installation of the reel simple and safe. All reels are delivered without connection hose.

Approved for use in ATEX-zone 22 in accordance with ATEX 2014/34/EU Equipment group II, Category 3D.

Product marking: CE EX II 3D c T=40°C X

Requirement for ATEX conformity (X):





The micro-switch should be connected to an intrinsic safe circuit or be left unconnected.

- Suitable for cleaning explosive dust
- With built-in automatic damper
- Integrated micro-switch
- Max. vacuum 45 kPa

Product name	Vacuum Hose Reel 881 Ex
Installation	Indoor
Suitable for combustible dust	True
Material recycling (%)	100
Connection hose length (ft)	33
Type of hose	PE/C
Distribution hose length (ft)	10
Max working pressure (psi)	
Note	With PE/C hose
Corrosion resistance	Standard
Electric/Spring driven	Spring





Vacuum Hose Reel 881 Ex

Image	Delivered with hose	Colour	Diameter, connection hose (in)	Distribution hose diameter (in)	Weight (lbs)	Max hose length	Model
		Blue	2	2	71		30806081*
		Blue		1 1/2	71		30805881*
	No	Blue			71	33	30805981
	Yes	Grey		1 1/2	57 - 66		30811081*

*With PE/C hose

Hose type	Specification	Temperature range, °C	Hose fittings in free hose end, distribution hose	Hose fitting on free hose end, inlet hose	Hose connection on reel, distribution hose	Hose connection on reel, inlet hose
PEC	For cleaning applications Max vacuum 50 kPa Conductivity < 10 ⁶ Ohm	-40 Deg. C. - +60 Deg. C.				

Vacuum Hose Reel 881 Ex

Accessory		Part No
	Circular crevice nozzle in plastic. Length: 360 mm. Width: 45 x 10 mm.	40193090*
	Circular crevice nozzle in steel Length: 310 mm. Width: 55 x 15 mm	40193620**
	Floor cleaning equipment width 400 mm with small nylon wheels	42932000*
	Floor cleaning equipment width 500 mm with small nylon wheels Ø51	42932100*
	Extended brush, 169 x 54 mm.	40190020*
	Hand nozzle, hard brush Ø90mm, Ø51	43860001*
	Hand nozzle, soft brush Ø90 mm	43860200*
	Floor cleaning equipment width 600 mm with small nylon wheels	42932200*
	Toothed nozzle width 130 mm, Ø51	43861001**
	Floor cleaning equipment width 400 mm with large rubber wheels Ø51	42932300*
	Brush hygiene, food industry	40190030*
	Floor cleaning equipment width 400 mm without wheels for wet suction	42932500**
	Cleaning equipment with 450 mm with rubber rim and brush	40377086***
	Floor cleaning equipment width 400 mm without wheels for dry suction Ø51	42932800*
	Cleaning equipment with 370 mm with rubber rim and brush	40377083***
	Rubber nozzle for confined spaces. Length: 230 mm. Width: Ø 32-38 mm.	40193130*
	Rubber nozzle for confined spaces. Length: 230 mm. Width: Ø 25-32 mm.	40193110*
	Cone nozzle Length 250 mm, Ø51	43862001**
	Round rubber brush with swivel top	40193080*
	Rebuilding kit to new micro switch	30375936
	Nozzle crevice plastic 60x15 D=40	40377194

*ATEX - Suitable for combustible dust with MIE (minimum ignition energy) < 1mJ. Ensure earthing to extraction unit. Not to be used in combustible gas atmospheres or extraction of explosive materials

**ATEX - Suitable for combustible dust (zone 20,21,22) and gas (zone 1,2) of group IIA , IIB and IIC. Ensure earthing to extraction unit. Not to be used for

Vacuum Hose Reel 881 Ex

extraction of explosive materials

****ATEX - Suitable for combustible dust (zone 20,21,22). Ensure earthing to extraction unit. Not to be used in combustible gas atmospheres or extraction of explosive materials.*

Vacuum Hose Reel 881 Ex

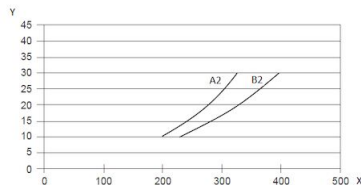
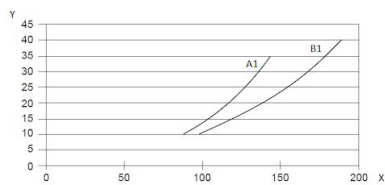
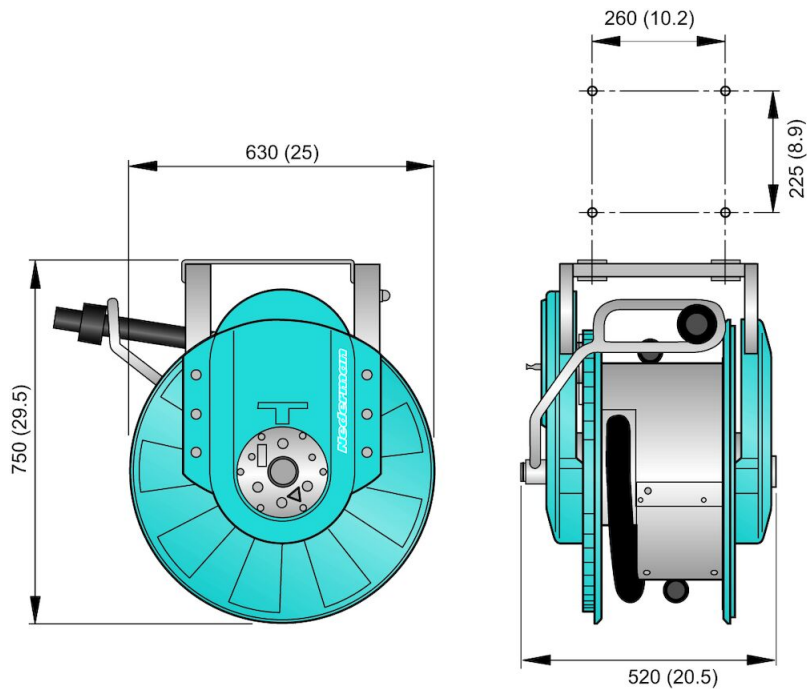

Y = Pressure drop (kPa)
X = Airflow (m³/h)

A1 = Hose 38 mm, coiled on reel
B1 = Hose 38 mm, fully uncoiled on floor
A2 = Hose 50 mm, coiled on reel
B2 = Hose 50 mm, fully uncoiled on floor