

## Bench Top Extraction Kits

Nederman Bench Top Extraction kits provide a quick and convenient solution for creating a fume-free workplace.















The Bench Top extraction kits includes arm(s) with hood or nozzle, fan with speed control and standard filter (particle, HEPA or gas), hose, connection details, and table bracket. The speed of the fan is variably controlled by a speed controller. Complete with hoses and extraction hoods. The hood is made of clear plastic, which increases the visibility.

---









Product name	Bench Top Extraction Kits
Power Voltage (V)	220 - 240
Electric plug	UK



## Bench Top Extraction Kits

Image	Description	Frequency (Hz)	Weight (kg)	Power (kW)	Model
	EK1000 kit includes 2 x FX32, Max airflow 42 m3/h	50 / 60	13	0,12	70508644
	EK1500 kit includes 3 x FX32, Max airflow 38 m3/h	50 / 60	15	0,12	70508744
	EK2000 kit includes 1 x FX50, Max airflow 100 m3/h	50 / 60	14	0,12	70508244
	EK2500 kit includes 2 x FX50, Max airflow 75 m3/h	50 / 60	17	0,12	70508344
	EK3000 kit includes 1 x FX75, Max airflow 150 m3/h	50 / 60	15	0,12	70508444
	EK500 kit includes 1 x FX32, Max airflow 45 m3/h	50 / 60	11	0,12	70508544
	EK1500 Carbon UK 240V includes 3 x FX32, Max airflow 38 m3/h per arm	50/60	18	0,12	67511734
	EK2000 Carbon UK 240V Includes 1x FX50, Max airflow 100 m3/h	50/60	18	1,1	67505144
	EK2500 Carbon UK 240V Includes 2x FX50, Max airflow 75 m3/h per arm	50/60	18	0,12	67505744
	EK3000 Carbon UK 240V includes 1x FX75, Max airflow 150 m3/h	50/60	18	0,12	67506344
	EK1000 Carbon UK 240V includes 2 x FX32, Max airflow 42 m3/h per arm	50/60	18	0,12	67511234
	EK500 Carbon UK 240V includes 1 x FX32, Max airflow 45 m3/h	50/60	15	0,12	67510734

## Bench Top Extraction Kits

	Accessory	Part No
	Trolley for EK system to suit FX2 Ø50 (Down-Through)	67000151
	Trolley for EK system to suit FX2 Ø75 (Down-Through)	67000152
	FX-Combi hood-ORIGINAL-D50/75/100	70500144
	FX-Dome hood-ORIGINAL-D50/75/100	70376982
	FX-Metal hood-ORIG/CHEM-D50/75/100	70500444
	FX-Flange hood-ORIGINAL-D50/75/100	70502844
	N3 filter standard	70311427
	Active carbon filter 4 kg	70312427
	Pre filter EK 1000-3000 1 pcs.	70333007

## Bench Top Extraction Kits

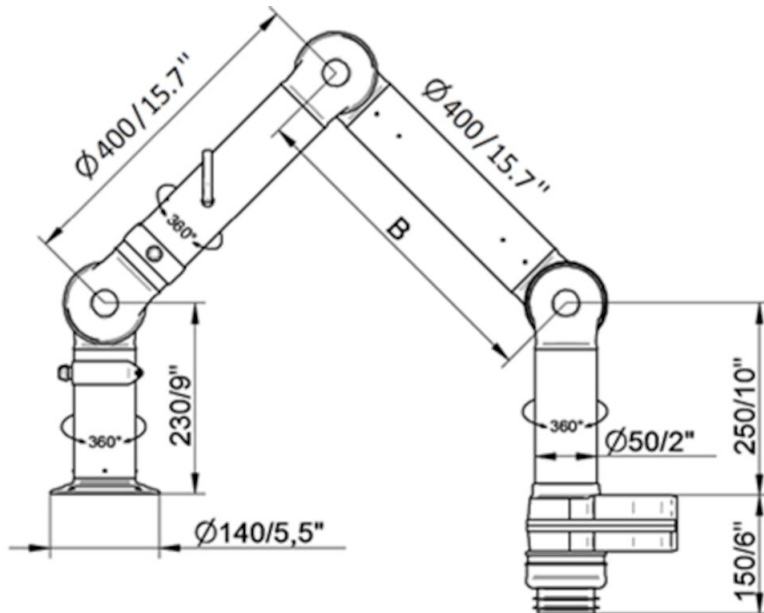

### EK 2000

Arm(s): 1 x FX2 50 arm

Hood(s): 1 x combination hood

Hose: Ø 75 mm (3 inch), 3000 mm (118 inch) length

Max. airflow: 100 m<sup>3</sup>/h (58.8 cfm)

### EK 2500

Arm(s): 2 x FX2 50 arm

Hood(s): 2 x mini hood

Hose: Ø 75 mm (3 inch), 3000 mm (118 inch) length

Max. airflow: 75 m<sup>3</sup>/h (44 cfm)

## Bench Top Extraction Kits

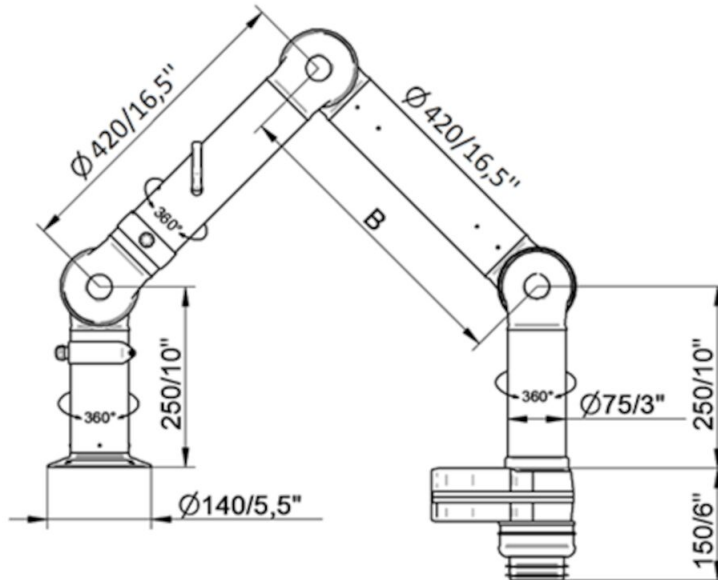

EK 3000  
Arm(s): 1 x FX2 75 arm  
Hood(s): 1 x mini hood  
Hose:  $\text{Ø}100$  mm (4 inch), 3000 mm (118 inch) length  
Max. airflow: 150 m<sup>3</sup>/h (88.3 cfm)

## Bench Top Extraction Kits

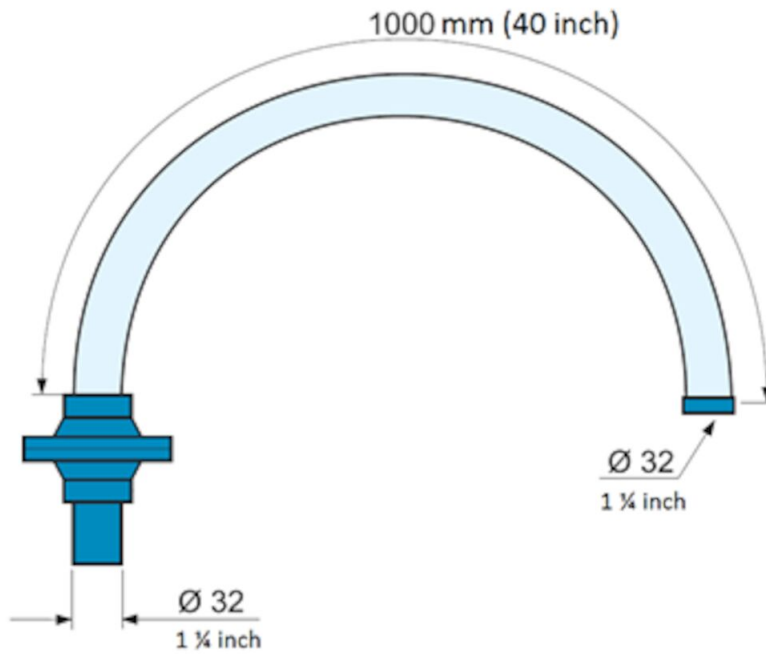

### EK 500

Arm(s): 1 x FX 32 arm

Hood(s): 1 x dome hood 1/2

Hose: Ø 45 mm (1 1/4 inch), 3000 mm (118 inch) length

Max. airflow: 45 m<sup>3</sup>/h (26.5 cfm)

### EK 1000

Arm(s): 2 x FX 32 arm

Hood(s): 2 x dome hood 1/2

Hose: Ø 45 mm (1 1/4 inch), 3000 mm (118 inch) length

Max. airflow: 42 m<sup>3</sup>/h (25 cfm)

### EK 1500

Arm(s): 3 x FX 32 arm

Hood(s): 3 x dome hood 1/2

Hose: Ø 45 mm (1 1/4 inch), 3000 mm (118 inch) length

Max. airflow: 38 m<sup>3</sup>/h (22.4 cfm)