

## Platforma do filtra FM

Możliwość dostawy platformy do każdego rozmiaru filtra FM

---

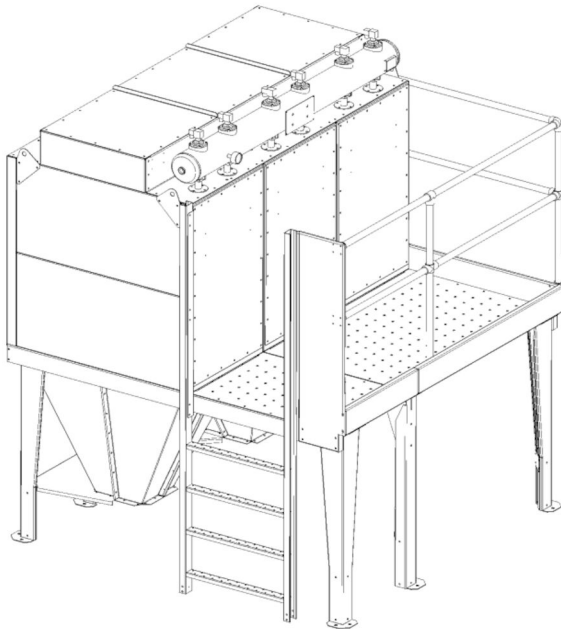

Możliwość dostawy platform do każdego rozmiaru filtra FM.  
Platforma jest bardzo szeroka.

Opis:







Platforma wykonana jest z ocynkowanych płyt stalowych. Drabina może być zamontowana albo z lewej, albo z prawej strony. Poręcz wykonana jest z ocynkowanej rury stalowej 1". Nogi filtra FM muszą być zamontowane wzdłuż przedniej krawędzi platformy. Fundament musi być dostosowany do rozmiarów platformy i filtra.

---

Nazwa produktu
----------------

Platforma do filtra FM
------------------------

# Platforma do filtra FM

Zdjęcie	Nazwa na karcie charakterystyki	Waga (kg)	Model
	Platform for FM filter with 2 modules	85	5501356
	Platform for FM filter with 4 modules	119	5501357
	Platform for FM filter with 6 modules	149	5501358
	Platform for FM filter with 8 modules	177	5501359
	Platform for FM filter with 6 modules, single outlet hopper	149	5501373
	Platform for FM filter with 8 modules, single outlet hopper	177	5501374

## Platforma do filtra FM

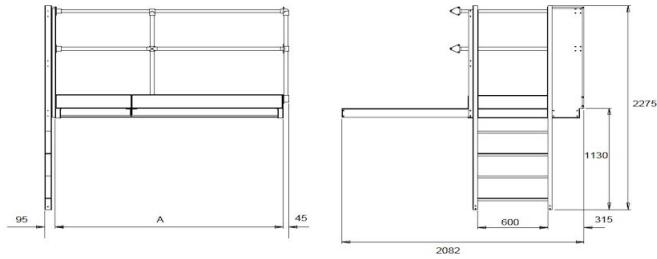

Filter size	A (mm)
FM – 2 modules	655
FM – 4 modules	1,304
FM – 6 modules	1,955
FM – 8 modules	2,605
FM – 6 module single outlet hopper	1,955
FM – 8 module single outlet hopper	2,605

\* The specified weight is for a standard ladder. Add 28 kg per extra 2 m ladder.