

NC cyclone

Basic cyclone to separate large materials from the airflow

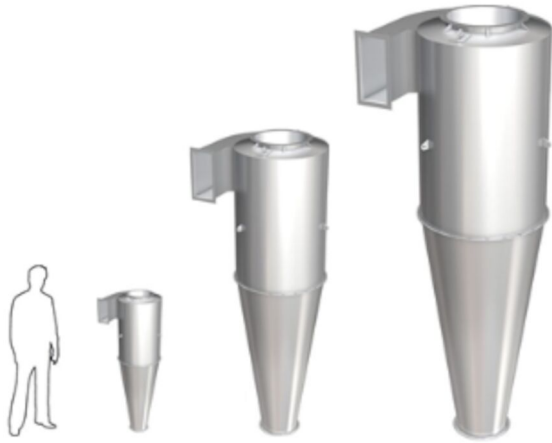

The cyclone is a separator that uses centrifugal force to purify air loaded with chips or dust. Its performance depends on the rotation speed, density and grading of particles. Cyclones are available with a wide range of accessories.









- Efficiency approx. 90% for particles above 10 micron.
- Higher efficiency for large particles.
- Built in 2 and 3 mm (.08 in and .1 in)-thick steel sheet depending on the size.
- Max temperature 75°C (167°F) with standard paint.

Nom du produit	NC cyclone
Installation	Extérieur
Matériel	2 and 3 mm (.08 in and .1 in)-thick steel sheet

NC cyclone

Nom de la fiche technique	Poids (kg)	[model]
	53	73003852
	53	73003846
	123	73003854
	123	73003847
	306	73003855
	306	73003848
	433	73003856
	433	73003849
	550	73003857
	550	73003850
	804	73003858
	804	73003851
	1278	73006417
	1278	73006415
Cyclone NHC 315	15	NHC315
	50	NHC630

NC cyclone

	[accessory]	[partno]
	Sortie tangentielle droite pour cyclone NC 500 gauche	73006362
	Sortie tangentielle gauche pour cyclone NC 500 droit	73003859
	Sortie tangentielle droite pour cyclone NC 500 gauche	73003870
	Sortie tangentielle gauche pour cyclone NC 700 droit	73003861
	Sortie tangentielle droite pour cyclone NC 1000 gauche	73003872
	Sortie tangentielle gauche pour cyclone NC 1000 droit	73003863
	Sortie tangentielle droite pour cyclone NC 1150 gauche	73003874
	Sortie tangentielle gauche pour cyclone NC 1150 droit	73003865
	Sortie tangentielle droite pour cyclone NC 1300 gauche	7906144
	Sortie tangentielle gauche pour cyclone NC 1300 droit	73003867
	Sortie tangentielle droite pour cyclone NC 1600 gauche	73003876
	Sortie tangentielle gauche pour cyclone NC 1600 droit	7989871
	Transition vers NRS(Z) 4 pour cyclone NC 700	73003878
	Transition vers NRS(Z) 4 pour cyclone NC 1000	73003879
	Transition vers NRS(Z) 4 pour cyclone NC 1150	73003880
	Transition vers NRS(Z) 4 pour cyclone NC 1300	73006363
	Transition vers NRS(Z) 4 pour cyclone NC 1600	73003881
	Transition vers NRS(Z) 4 pour cyclone NC 2000	73006438
	Transition vers NRS(Z) 4 pour cyclone NC 2500	73006439
	Transition vers NRS(Z) 4 pour cyclone NC 500	73003877
	Transition vers NRS(Z) 10 pour cyclone NC 700	73003882
	Transition vers NRS(Z) 10 pour cyclone NC 1000	73003883

NC cyclone

	[accessory]	[partno]
	Transition vers NRS(Z) 10 pour cyclone NC 1150	73003884
	Transition vers NRS(Z) 10 pour cyclone NC 1300	73003885
	Transition vers NRS(Z) 10 pour cyclone NC 1600	73006364
	Transition vers NRS(Z) 10 pour cyclone NC 2500	73003886
	Bac à poussières pour cyclone NC500	73007861
	Bac à poussières pour cyclone NC700	73007862
	Bac à poussières pour cyclone NC1150	73007864
	Bac à poussières pour cyclone NC1300	73007865
	Bac à poussières pour cyclone NC1600	73007866
	Ex tangential outlet left for NC 1150 right cyclone	73003866*
	Ex tangential outlet right for NC 1300 left cyclone	73006431*
	Cyclone NC 500 galvanized inlet, QF 200	73006355
	Cyclone NC 700 galvanized inlet, QF 250	73003319
	Cyclone NC 700 galvanized inlet, QF 315	73003320
	Cyclone NC 700 galvanized inlet, QF 350	73003321
	Cyclone NC 1000 galvanized inlet, QF 350	7988029
	Cyclone NC 1150 galvanized inlet, QF 350	73003323
	Cyclone NC 1150 galvanized inlet, QF 400	73006378
	Cyclone NC 1300 galvanized inlet, QF 400	73003324
	Cyclone NC 1300 galvanized inlet QF 500	73006469
	Cyclone NC 1600 galvanized inlet QF 560	73006472
	Cyclone NC 1600 galvanized inlet QF 630	73006474

NC cyclone

[accessory]	[partno]
Cyclone NC 500 galvanized inlet FL 250	73006488
Cyclone NC 700 galvanized inlet, FL 250	73003589
Cyclone NC 1000 galvanized inlet, FL 400	73001191
Cyclone NC 1150 galvanized inlet, FL 400	7983444
Cyclone NC 1300 galvanized inlet, FL 450	7980966
Cyclone NC 1300 galvanized inlet FL 500	73006496
Cyclone NC 500 2mm welded inlet FL 200	73006538
Cyclone NC 500 2mm welded inlet FL 224	73006539
Cyclone NC 500 2mm welded inlet FL 250	73006540
Cyclone NC 1300 2mm welded inlet FL 400	73006547
Cyclone NC 1300 2mm welded inlet FL 450	73006548
Cyclone NC 1300 2mm welded inlet FL 500	73006549
Cyclone NC 1600 2mm welded inlet FL 450	73006550
Cyclone NC 1600 2mm welded inlet FL 500	73006551
Cyclone NC 1600 2mm welded inlet FL 550	73006552
Cyclone NC 1600 2mm welded inlet, FL 560	73005433
Cyclone NC 2000 2mm welded inlet FL 800	73006560
Cyclone NC 2500 2mm welded inlet FL 800	73006561
Cyclone NC 2500 2mm welded inlet, FL 900	73003688

**Les panneaux d'explosion sur la sortie tangentielle Ex ont été calculés sur la base de la valeur de la poussière indiquée dans le tableau Poussière. Pour les cyclones dans une installation travaillant avec des poussières explosives, le client doit faire des calculs supplémentaires pour la zone d'aération. La zone de décharge dans la prise tangentielle Ex peut être trop petite pour les conditions et toute l'installation.*

NC cyclone

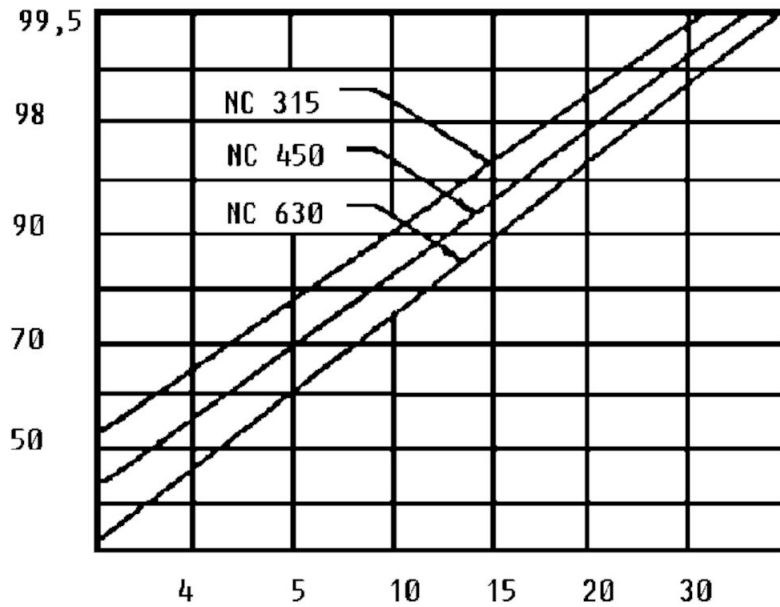

Efficiency NHC 315-630

X= %
Y= µm

Dust value				
	K_v [bar]	P_{max} [bar]	Volume [m ³]	Parties Qty.
NC 500	150	6	0,24	1
NC 700	170	6	0,68	1
NC 1000	100	6	2,01	1
NC 1150	130	6	3,15	1
NC 1300	125	6	4,49	1
NC 1600	115	6	7,74	1
NC 2000	160	6	13,99	2
NC 2500	170	6	24,12	3

NC cyclone

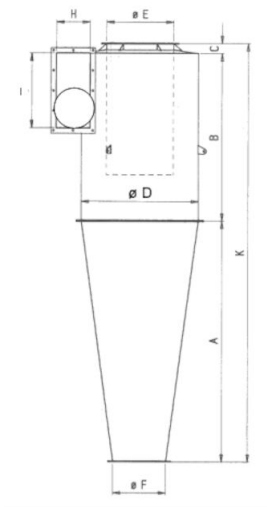
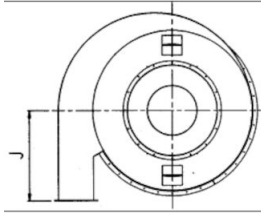

Dimensions

Type	A	B	C	Ø D	Ø E	Ø F	H	I	J	K	Weight
	[mm]	[mm]	[mm]	[mm]	[mm]	[mm]	[mm]	[mm]	[mm]	[mm]	[kg]
NC 500	1000	700	80	500	250	200	126	285	305	1780	53
NC 700	1430	990	60	700	400	315	206	444	501	2480	123
NC 1000	2048	1500	100	1000	560	400	216	485	606	3648	306
NC 1150	2395	1800	100	1150	630	450	240	550	675	4300	433
NC 1300	2825	2000	120	1300	710	450	300	600	700	4945	550
NC 1600	3300	2300	100	1600	900	500	357	905	600	5700	804
NC 2000	3930	2600	170	2000	1200	630	401	1247	1200	6700	1278
NC 2500	4205	3000	170	2500	1600	710	507	1364	1200	7375	1647

Dimensions Cyclone type 500-2500

NC cyclone

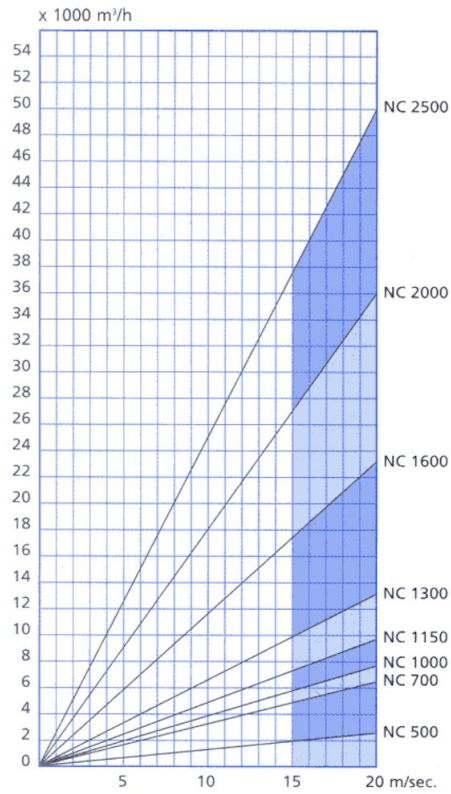
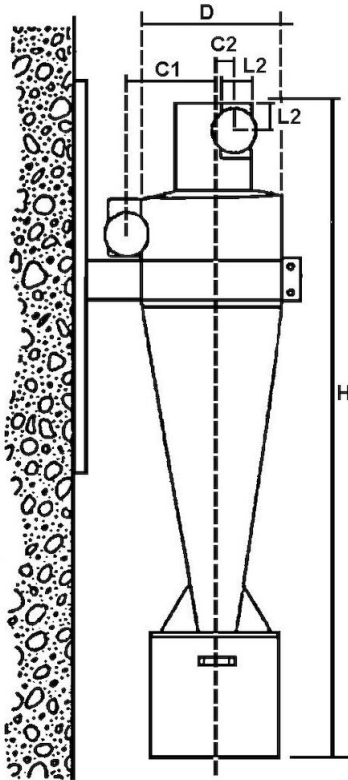

Diagram NC 500-2500

NC cyclone



Type	C1	L1	C2	L2
315	189	252	58	63
450	270	360	80	90
630	378	500	115	125

NC cyclone

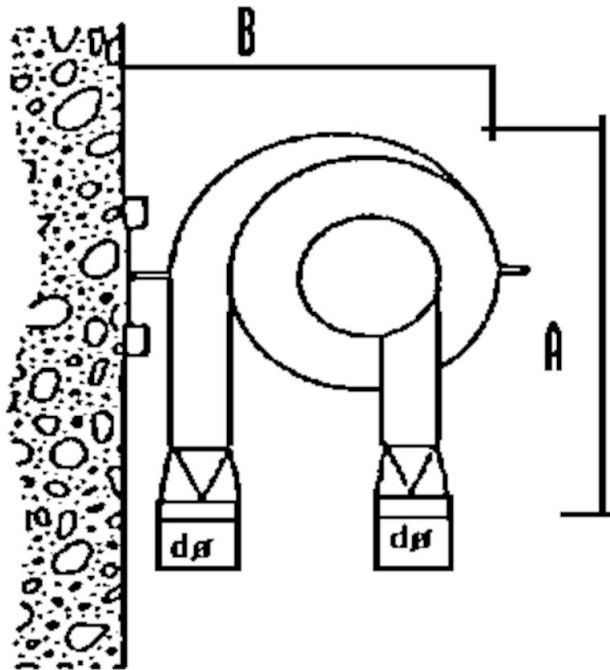

Type	D (mm)	A (mm)	B (mm)	H (mm)	d (mm)	Vægt (kg)	Art. no. Cyclone right	Art. no. Cyclone left	Art. no. Wall support
NHC 315	315	500	500	1550	100	15	47100.315	47101.315	47190.315
NHC 450	450	600	650	2100	125	20	47100.450	47101.450	47190.450
NHC 630	630	700	750	2700	160	50	47100.630	47101.630	47190.630

All dimensions in mm

NC cyclone

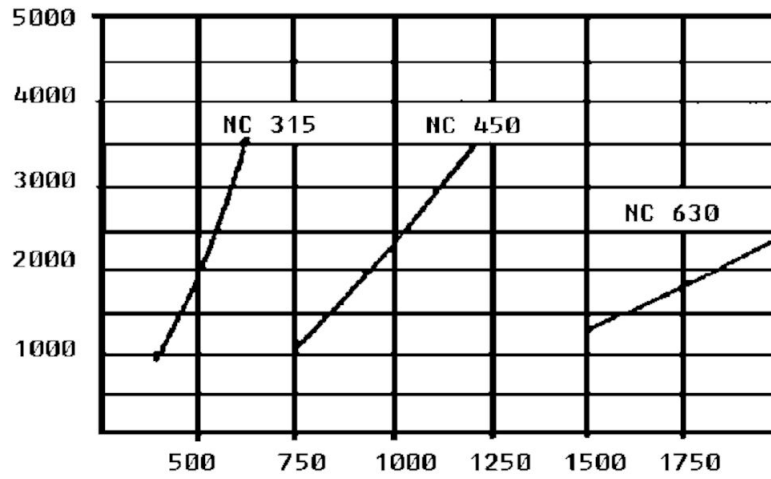

Pressure drop diagram for NHC315-630

X = Pa
Y = m/h