

## Aspirador industrial 600A EX

Coletor de poeira fixo e potente



A powerful stationary dust collector, excellent high vacuum for suction over long horizontal and vertical distance.

You can choose a dust collector with bigbag holder and counterweight discharge valve or a dust collector with a manual discharge valve. Equipped with efficient and self-cleaning bag filters.

600A EX is category 2GD equipment according to directive 2014/34/EU. This means that it may be placed in areas classified as zone 21 or 1 according to directive 1999/92/EC. However, 600A EX may not be used to vacuum combustible material; they are only for use with non-combustible dusts. This is since they lack a protection system to limit the effects of an internal explosion, hence the X in ATEX marking.

ATEX approved equipment: II 2GD c IIB 60°C (T6) X

- Filtro autolimpante robusto e eficiente
- Ejetor gerador de vácuo, muito potente e confiável
- Ejetor gerador de vácuo, muito potente e confiável
- Pernas com opção para duas alturas

Produto	Aspirador industrial 600A EX
Instalação	Interior
Método de limpeza do filtro	Ar comprimido
Aplicações	Poeira, Granulado, Areia, Granalha
Volume do balde (l)	146
Área Filtrante (m <sup>2</sup> )	2,5
Tipo de filtro	Filtro de velas
Material Filtrante	Antistatic Polyester
Compressed air requirement	5,3 Nm <sup>3</sup> /min
Max airflow (m <sup>3</sup> /h)	318
Índice de ruído (dB(A))	75
Vácuo máx. (kPa)	-78
Inlet	76 mm (reducer to ø 51 mm included)
Peso (kg)	240
Hose length (m)	10
Hose diameter (mm)	51
Nota	ATEX - EX II 2 GD c IIB 60°C(T6) (Not for combustible dust)



Granulado



Areia

Granalha

Poeira











## Aspirador industrial 600A EX

Imagem	Descrição	Modelo
	600A EX, NE74, 1 quick coupling, with manual discharge valve	42260000*
	600A EX, NE74, 1 quick coupling, with bigbag holder and counterweight discharge valve	42260001*

\*ATEX - EX II 2 GD c IIB 60°C(T6) (Not for combustible dust)

## Aspirador industrial 600A EX

Acessório		Artigo nº
	Mangueira PU12 Ø 51 L=10m com acopladores	43832200*
	Bocal para chão, largura 400 mm com rodas de borracha grandes, Ø51mm	43840250**
	Tubo cotovelo, Ø51mm	43842150***
	Bocal para material a granel, 910 x Ø51mm	43850001****
	Bocal raspador, comprimento: 500mm, Ø51mm	43851050***
	Bocal manual, Escova macia Ø90 mm	43860200****
	Bocal cônico, comprimento 250 mm, Ø51mm	43862001*****
	Redução cônica d76-51mm, aço inox	43880300
	Abr plate for silo S200, inside 210x643 (R280)	43627001

\*Couplings included, Ø 51 mm

\*\*ATEX - This product is suitable to be used as cleaning equipment for combustible dusts with MIE (minimum ignition energy) >1 mJ. Product is to be properly earthed to the extraction unit. Not for usage in combustible gas atmospheres or extraction of explosive materials.

\*\*\*ATEX - Suitable for combustible dust (zone 20,21,22) and gas (zone 1,2) of group IIA, IIB and IIC. Ensure earthing to extraction unit. Not to be used for extraction of explosive materials

\*\*\*\*ATEX - Adequado para poeira combustível (zona 20,21,22). Assegurar ligação à terra da unidade de extração. Não deve ser usado em atmosferas com gás combustível ou extração de materiais explosivos.

\*\*\*\*\*Adequado para poeiras combustíveis (zona 20,21,22) e gases (zona 1,2) dos grupos IIA, IIB e IIC. Assegurar ligação à terra da unidade de extração. Não deve ser usado em atmosferas com gás combustível ou extração de materiais explosivos.

## Aspirador industrial 600A EX

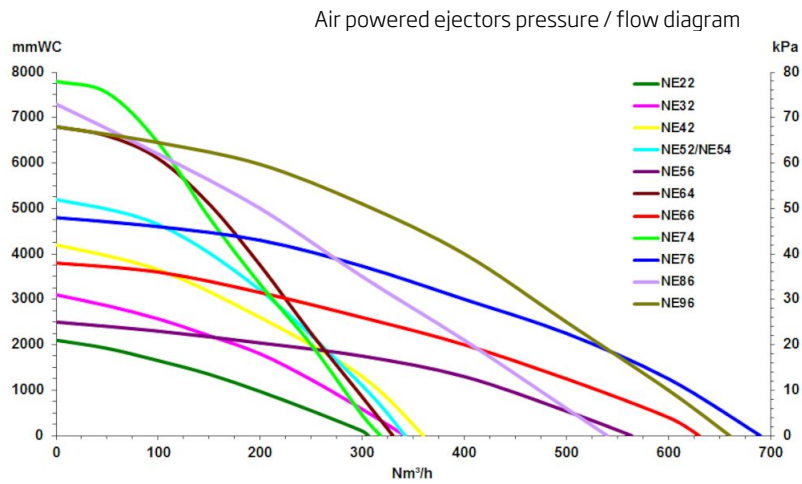

Air Powered ejectors

All performance data are based on 7 bar supply pressure

Necessary hose dimension for compressed air line								
Vacuum producer	Standard suction hose diameter (mm)	Distance from compressor (m)						
		12mm (1/2")	20mm (3/4")	25mm (1")	32mm (1 1/4")	38mm (1 1/2")	51mm (2")	63mm (2 1/2")
NE14	38	1-8	9-58	59-200	201+			
NE22	51	1-8	9-58	59-200	201+			
NE32	51		2-22	23-69	70-110	111+		
NE42	51		1-8	9-41	42-100	101+		
NE52	51		1-6	7-29	30-70	71-160	161+	
NE56	63		1-7	8-39	40-90	91-190	191+	
NE64	76			1-21	22-41	42-102	103+	
NE66	63			1-25	26-47	48-150	151+	
NE74	76			1-15	16-31	32-63	64+	
NE76	76			1-14	15-30	31-71	72+	
NE96	76			1-4	5-11	12-32	33-125	126+

Necessary hose dimension for compressed air line

# Aspirador industrial 600A EX

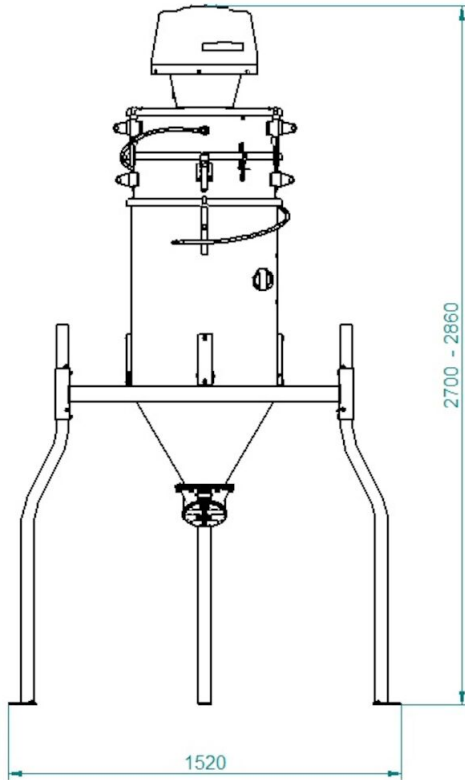

# Aspirador industrial 600A EX

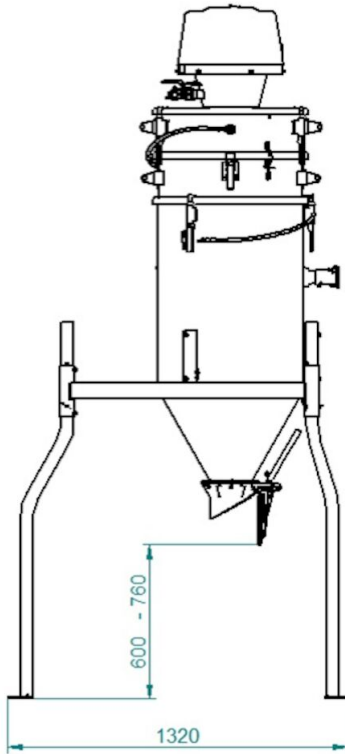

# Aspirador industrial 600A EX

