

570A, Configurable

A powerful dust collector, excellent high vacuum for suction over long horizontal and vertical distances



The configuration of modules will be similar to 570A which are aimed for the toughest applications, for example handling a lot of abrasive and heavy material. The robustness of the unit and the power from the reliable ejector makes the unit very suitable for many applications where many industrial vacuum cleaners can not be used. For example to collect blasting material in blasting hall, sand recovery in foundries etc.

Your unit can be configured to meet your specific demands. Different ejectors can be used depending on the demand but also the availability of compressed air. The ejector can be placed on a mobile silo with filter, with wheels and forklift slots.

Nederman has a range of different discharge valves that can be fitted to the silo for easy discharge of the collected material.

If handling larger quantities of material, Nederman recommends using a pre separator before the vacuum unit. See Nederman Engineering Guide for more information.

Use modules linked to 570A, configurable only. You may only choose ejectormodule, filtermodule, silomodule and discharge valve

1. Select ejectormodule depending on required vacuum and air flow.
2. Select filtermodule depending on filter capacity.
3. Select silomodule.
4. Select discharge valve.
5. Select cleaning equipment.

Choose how to control your butterfly valve:

1. Electric controlled - You need a namur valve, solenoid valve recommended for the ejector size you choose and a control box.
2. Air controlled - You need a namur valve.

Hose for air supply to the namur valve is not supplied by Nederman.

Control system with many different functions is available as an accessory

Ensure you meet all requirements for your modules.

- Silo system with large wheels
- Suitable for heavy and or abrasive material
- Robust and efficient self-cleaning filter

Product name	570A, Configurable
Filter cleaning method	[CompressedAir]
Application	[dust], [granulate], [grit], [swarf]
Filter type	[NCF]
Number of filter elements	70
Inlet	Ø76mm









Granulate Grit Swarf Dust



570A, Configurable























570A, Configurable

[Image]	Description	Compressed air requirement	Max airflow (m³/h)	Noise level (dB(A))	Max vacuum (kPa)	Weight (kg)	[model]
	NE64, Ejectormodule with S200 lid and 2 quick couplings	4,3 Nm3/min @ 7 bar	330 Nm3/h	77	-68	18	43051000*
	NE74, Ejectormodule with S200 lid and 2 quick couplings	5,3 Nm3/min @ 7 bar	318 Nm3/h	75	-78	18	43051001*
	NE76, Ejectormodule with S200 lid and 2 quick couplings	5,4 Nm3/min @ 7 bar	690 Nm3/h	78	-48	18	43051002**
	NE96, Ejectormodule with S200 lid and 2 quick couplings	8,6 Nm3/min @ 7 bar	660 Nm3/h	78	-68	18	43051003**
	Filtermodule NCF, 3,15 m2 filterarea, I S200 Vyon F. MFC					40	43162101
	Filtermodule NCF, 5,25 m2 filterarea, I S200 Vyon F. MFC					55	43164101
	Mobile S200 Silo with plastic fasteners and abrasion plate. Volume 146 l					80	43470034



















*Recommended with filtermodule 43162101

**Recommended with filtermodule 43164101

570A, Configurable

	[accessory]	[partno]
	Discharge valve manual	43630001*
	Discharge valve with counterweight	43630200*
	Discharge valve, pneumatically operated	43630100*
	Pinch valve DN65	43632001
	Pinch valve DN80	43632100
	Manually operated butterfly discharge valve	43630400**
	Hose PU12 Ø 51 L=10m	43832600
	Hose PU12 Ø 51 L=5m	43832500
	Hose PU12 Ø 51 L=20m	43832300
	Hose PU12 Ø 51 L=7,5m w. couplings	43832102***
	Hose PU12 Ø 51 L=10m w. couplers	43832200***
	Hose PU12 Ø 63 L=5m	43833200
	Hose PU12 Ø 63 L=10m	43833001
	Hose PU12 Ø 63 L=20m	43833100
	Hose PU12 Ø 76 L=10m	43834200
	Hose PU12 Ø 76 L=20m	43834300
	Mountingplate for controlbox, S200	43690001
	Control system for ejectors	43220034
	Level control for silo continuous feed out	43251001
	Bin Level indicator (BLI) EX	40375269
	Floor cleaning equipment width 500 mm with small nylon wheels Ø51 and rubber lips	42932100****
	Floor cleaning equipment width 400 mm without wheels for dry suction Ø51, with brushes	42932800****

570A, Configurable

	[accessory]	[partno]
	Floor cleaning equipment width 400 mm with large rubber wheels Ø51 and rubber lips	42932300****
	Floor nozzle, width 500 mm with small nylon wheels, Ø51	43840150*****
	Floor nozzle, width 400 mm with large rubber wheels, Ø51	43840250*****
	Floor nozzle width 400 mm without wheels for dry suction, Ø51	43840550*****
	Hand nozzle, hard brush Ø90mm, Ø51	43860001****
	Toothed nozzle width 130 mm, Ø51	43861001*****
	Cone nozzle Length 250 mm, Ø51	43862001*****
	Elbow pipe, Ø51 mm	43842150*****
	Cleaning pipe, length 1100 mm, Ø51 mm	43842001*****
	Bulk nozzle for floor with handle length 1200 mm, Ø51 mm	43850150*****
	Bulk nozzle Length 910 mm, Ø51	43850001****
	Scraper nozzle, length: 1000 mm Ø51	43851150*****
	Scraper nozzle, length: 500 mm Ø51	43851050*****
	Steel swarf nozzle, Ø50 mm, Silenced inlet	40150030*****
	Floor suction head width 500mm, Ø63	43840400****
	Bulk nozzle length 910 mm, galvanized, Ø63	43850050*****
	Bulk nozzle length 910 mm for swivel (43843100), Ø63	43850051*****
	Bulk nozzle for floor, length 1200 mm, Ø63 mm	43850200*****
	Scraper hand nozzle, length 1000 mm, Ø63	43851200*****
	Suct pipe bend alum d63	43843050****
	Swivel steel d63	43843100****
	Suction pipe aluminium Ø63	43843001****

570A, Configurable

	[accessory]	[partno]
	Scraper hand nozzle, length 500 mm, Ø63	43851100*****
	Bulk nozzle length 910 mm, d76, galvanized	43850100*****
	Bulk nozzle with handle, Ø76	43850250*****
	Scraper hand nozzle, length 1000 mm, Ø76	43851250*****
	Reducer conical d76-63, Acid stainless steel	43880350
	Reducer conical d76-51, Acid stainless steel	43880300
	Hose red conical d63-51	43880250
	Hose connector d63	43880100
	Hose connector d50	43880050
	Hose joint d76, Acid stainless steel	43880150
	Electrical control system for ejectors NE 22-76. (Suction time: 0-5 min, Discharge time: 0-15 sek)	43220001
	Timer electrical control for ejector NE 22-76, without control box. Mounted on the compressed air connection. (Suction time: 0 - 15 min, Discharge time: 0-15 sek)	43220026
	Timer electrical control for ejector NE 86-96, without control box. Mounted on the compressed air connection. (Suction time: 0 - 15 min, Discharge time: 0-15 sek)	43222008
	Floor suct head d63/600	43840450*****

*Ø150mm Housing and flap in PA. Temp range -20C to +40C. Height: 155 mm (240 mm in open position)

**Ø125mm Housing in NBR, Epoxy coated cast iron and flap/sleeve i stainless steel. Temp range -20C to +120C. Height: 110 mm (260 mm in open position)

***Couplings included, Ø 51 mm

****ATEX: Suitable for combustible dust (zone 20,21,22). Ensure earthing to extraction unit. Not to be used in combustible gas atmospheres or extraction of explosive materials.

*****ATEX: This product is suitable to be used as cleaning equipment for combustible dusts with MIE (minimum ignition energy) >1 mJ. Product is to be properly earthed to the extraction unit. Not for usage in combustible gas atmospheres or extraction of explosive materials.

*****ATEX: This product is suitable to be used as cleaning equipment for combustible dusts with MIE (minimum ignition energy) >1 mJ. Product is to be properly earthed to the extraction unit. Not for usage in combustible gas atmospheres or extraction of explosive materials.

*****ATEX: Suitable for combustible dust (zone 20,21,22) and gas (zone 1,2) of group IIA, IIB and IIC. Ensure earthing to extraction unit. Not to be used for extraction of explosive materials

570A, Configurable

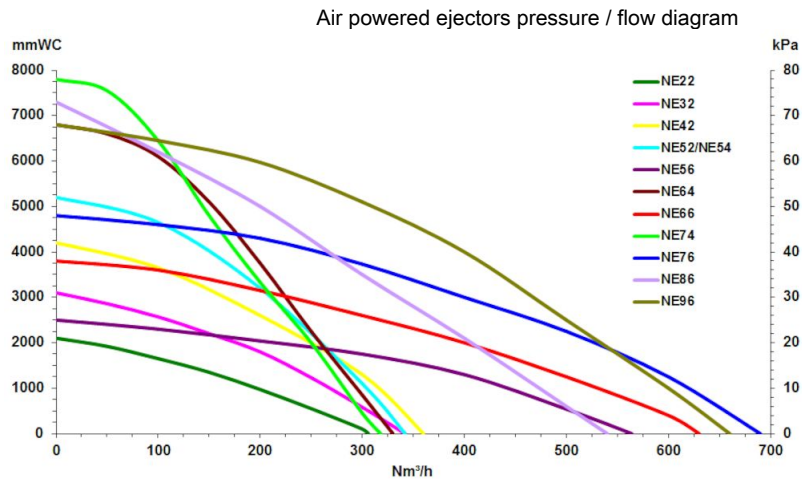

Air Powered ejectors

All performance data are based on 7 bar supply pressure

Ejector/Hose dimension	ø51mm	ø63mm	ø76mm
NE64	2	2,4	N/A
NE74	2,3	2,7	N/A
NE76	1,7	2,7	3,6
NE96	2,6	3,6	4,9

Capacity (tonne/hour) with Blasting media 2,4kg/liter and 20m hose

570A, Configurable

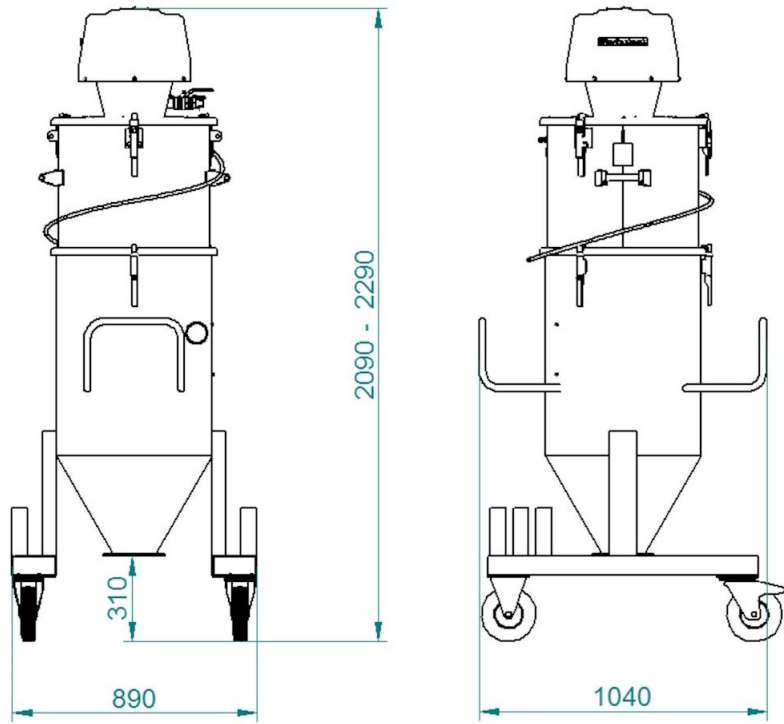

The height of the configuration is depending on filtermodule choosen.