

BenchTop Extraction Arm FX2 50 Original

The best and most cost-efficient solution for applications where small, flexible and easy-to-use arms are required.

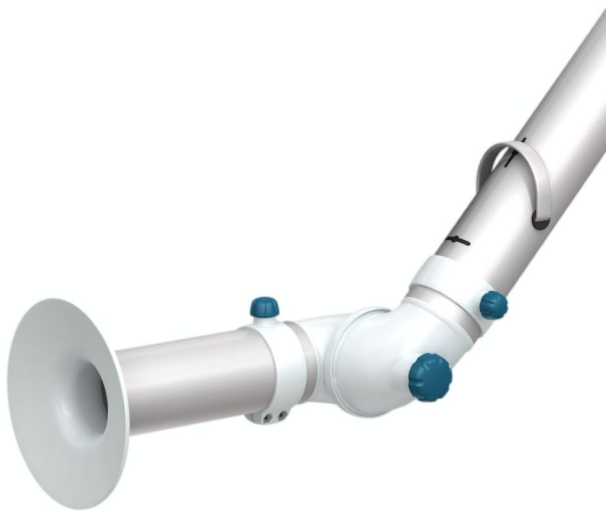

Nederman FX2 arms are made of lightweight anodized aluminium sections, with two or three adjustable, composite friction joints. Offering strength and durability combined with easy handling, they can be used in many types of environment. They are especially suitable for applications where small, flexible and easy-to-use arms are required.











A robust and reliable all-round arm for general applications where there is little risk of electrical discharges or attack by aggressive chemicals.

- Optimal efficiency and low noise provides safe and quiet working environment
- Ceilings, walls and floors or fixed to worktops mountings and cut2fit extension profile gives maximum installation flexibility
- The two outermost arm joints can rotate and swivel through 360°, which gives the unique maneuverability
- The lean, smooth and aesthetic design allows arms to fit in well in any environment without compromising its durability and reliability
- Highly integrated products that save customers' time and costs, as well as providing the reliability and functionality to deliver a better performance



















Product name	BenchTop Extraction Arm FX2 50 Original
Noise level (dB(A))	60 dB(A) at 110 m3/h
Installation	[Indoor]
Material	Tubes in anodized aluminium. Joints in PP plastic. Duct connectors in EPDM rubber. Minihood in PP plastic.
Fume temperature	max 70°C
Extraction arm diameter (mm)	50
Airflow (m³/h)	50 - 110
Arm length (m)	



BenchTop Extraction Arm FX2 50 Original

[image]	Description	Weight (kg)	[model]
	FX2-ORIG-D50-L700-Up/Down-Low	1,7	70600144
	FX2-ORIG-D50-L700-Up-PLUS	2,7	70600244
	FX2-ORIG-D50-L700-Up/Down-Through	1,2	70600344
	FX2-ORIG-D50-L1100-Up-Low	2,3	70600444
	FX2-ORIG-D50-L1100-Up-PLUS	3,3	70600544
	FX2-ORIG-D50-L1100-Down-Low	2,3	70600644
	FX2-ORIG-D50-L1100-Down-Through	1,8	70600744
	FX2-ORIG-D50-L1500-Up-Low	2,6	70600844
	FX2-ORIG-D50-L1500-Up-PLUS	3,6	70600944
	FX2-ORIG-D50-L1500-Down-Low	2,6	70601044
	FX2-ORIG-D50-L1500-Down-Through	2,1	70601144

BenchTop Extraction Arm FX2 50 Original

	[accessory]	[partno]
	FX-Bracket kit-D50/75/100-L190	70501144
	FFX2-Bracket kit-D50/75/100-L500	70377042
	FX2-Wall BRKT kit-Flat-L190-White	70377043
	FX2-Wall-P BRKT kit-D50/75/100-L190	70377046
	FX2-Bench bracket kit-D50/75/100. Complete mounting kit for mounting FX2 50/75/100 arms on the bench edge.	70501444
	FX-Classic bracket-D50/75/100. The classic bracket should be used together with Cut2fit extension profile for mounting FX2 50/75/100 arms on the ceiling, wall, floor or on top of other horizontal surface.	70501244
	FX-Cut2fit extension-L1100.	70501344
	FX-Cut2fit extension-L2200	70374600
	FX-Ceiling cover plate. Cover false/dropped ceiling openings caused by both extension profile and ducting.	70502644
	FX2-Ceiling cover plate-PLUS	70377045
	FX-Combi hood-ORIGINAL-D50/75/100	70500144
	FX-Dome hood-ORIGINAL-D50/75/100	70376982
	FX-Metal hood-ORIG/CHEM-D50/75/100	70500444
	FX-Flange hood-ORIGINAL-D50/75/100. Transparent flange hood, made of PET-G plastic, is designed to maximize the capture zone without hinder objects on the bench or the user. It can be attached directly on minihood, irrespective of arm size.	70502844
	FX2-Duct connector-ORIG/CHEM-D50	70377036
	FX2-AI duct-L1000-D50toD77	70377056
	FX2-AI duct-L2000-D50toD77	70377057
	FX2-Hose support ring-D75	70377067

BenchTop Extraction Arm FX2 50 Original

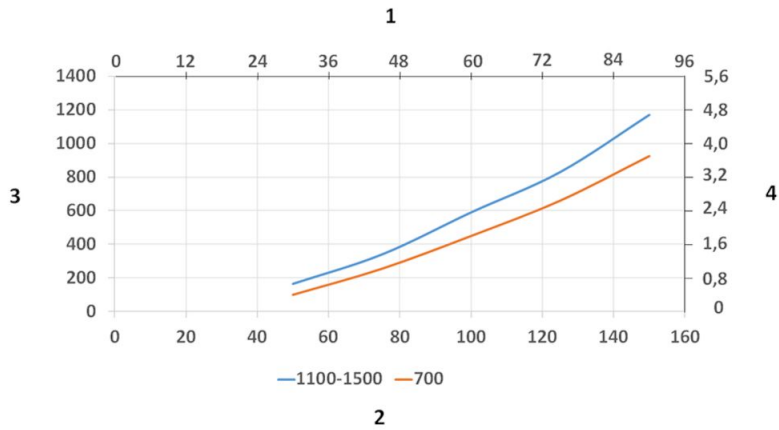

Pressure Drop diagram:

1) X- Axis: Air Flow Rate (cfm)

2) X- Axis: Air Flow Rate (m/h)

3) Y-Axis: Static Pressure Drop (Pa)

4) Y-Axis: Static Pressure Drop (in. wg.)

BenchTop Extraction Arm FX2 50 Original

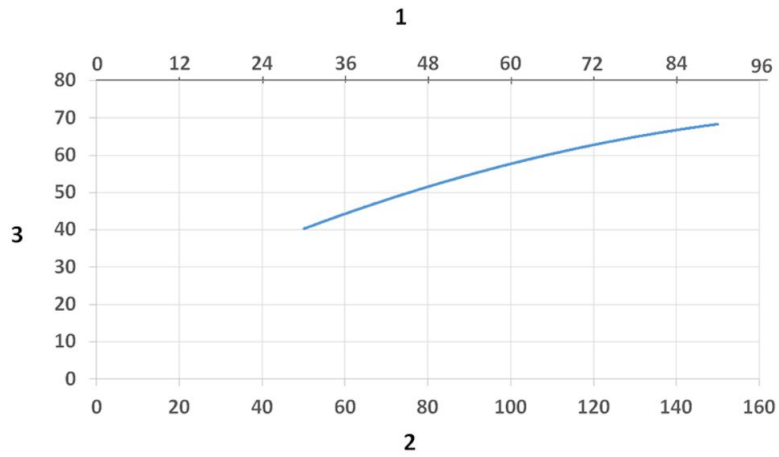

Sound Level diagram:

1) X- Axis: Air Flow Rate (cfm)

2) X- Axis: Air Flow Rate (m/h)

3) Y-Axis: Sound Pressure Level (dB) (A))

BenchTop Extraction Arm FX2 50 Original

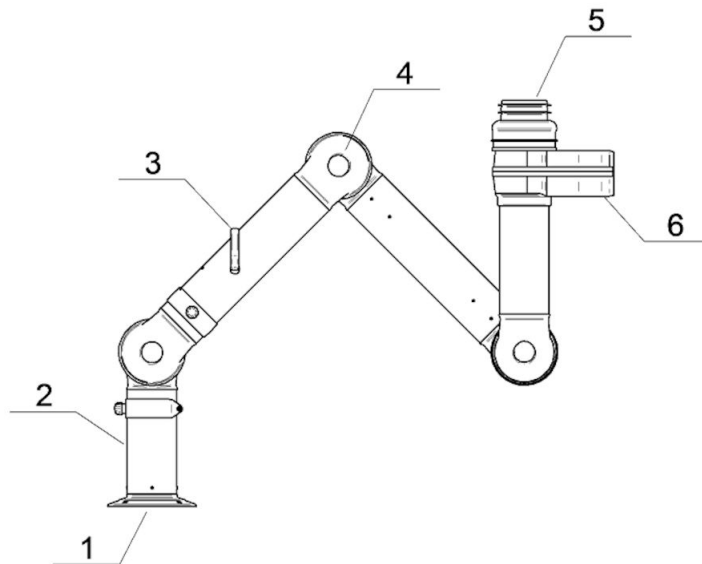

Material:

1) Flange: PP

2) Tubes: Aluminum, anodized 10 µm

3) Damper adjustment handle: Aluminum, anodized 10 µm
Internal spring: Stainless steel
Damper blade: Conductive TP & PP plastic

4) Joints: PP with glass fibre reinforcement
Plastic rings: PP with glass fibre reinforcement
Axial locking rings: PP with glass fibre reinforcement
Adjustment knobs: PA & EDS plastic
Threaded shaft inside joints: Stainless Steel

5) Duct connector: EPDM Rubber

6) Swivel: Aluminum, powder coating
Rivets: Aluminum
Bearings swivel: PP plastic with glass fibre reinforcement

BenchTop Extraction Arm FX2 50 Original

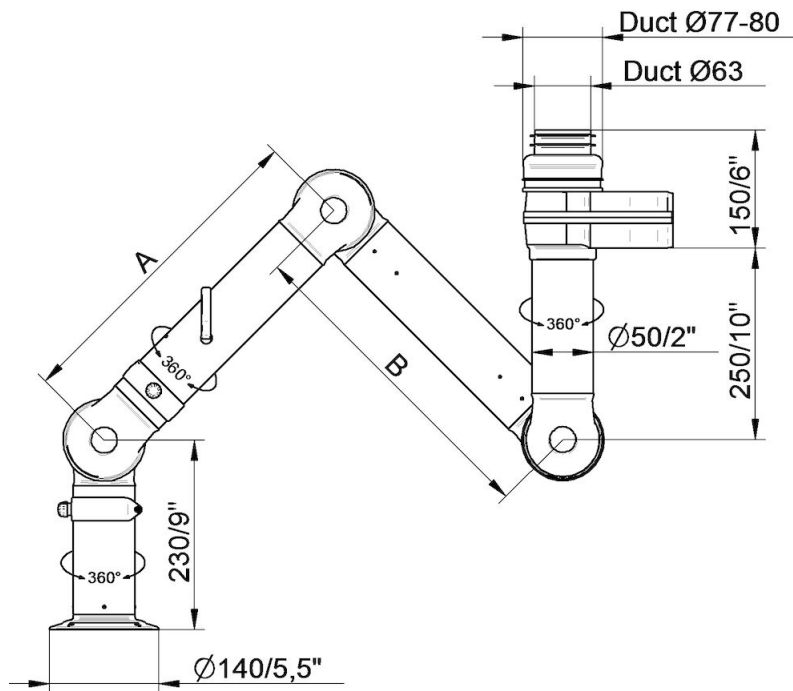

- FX2-ORIG-D50-L700-Up/Down-Low
Part number: 70600144
Max. working radius: 630 mm (24,8 in)
A: 400 mm (15,7 in)

- FX2-ORIG-D50-L1100-Up-Low
Part number: 70600444
Max. working radius: 1030 mm (40,5 in)
A: 400 mm (15,7 in)
B: 400 mm (15,7 in)

- FX2-ORIG-D50-L1500-Up-Low
Part number: 70600844
Max. working radius: 1430 mm (56,3 in)
A: 500 mm (19,7 in)
B: 700 mm (27,6 in)

BenchTop Extraction Arm FX2 50 Original

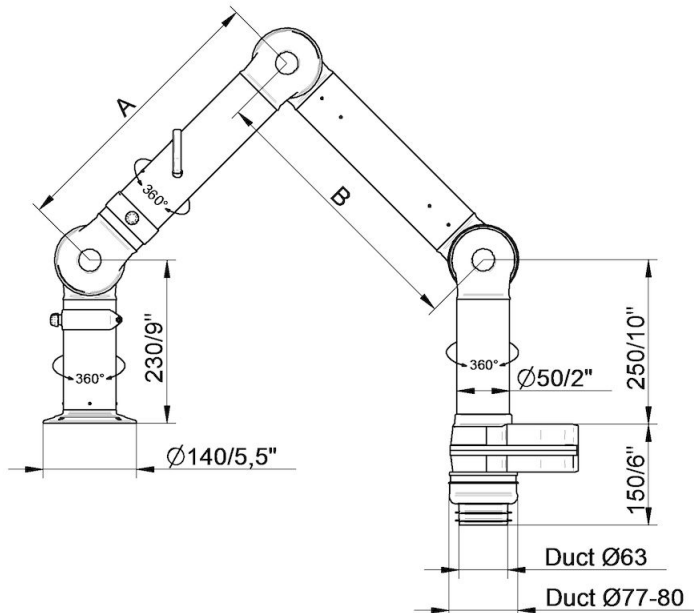

- FX2-ORIG-D50-L700-Up/Down-Low
Part number: 70600144
Max. working radius: 630 mm (24,8 in)
A: 400 mm (15,7 in)
B: -

- FX2-ORIG-D50-L1100-Down-Low
Part number: 70600644
Max. working radius: 1030 mm (40,5 in)
A: 400 mm (15,7 in)
B: 400 mm (15,7 in)

- FX2-ORIG-D50-L1500-Down-Low
Part number: 70601044
Max. working radius: 1430 mm (56,3 in)
A: 500 mm (19,7 in)
B: 700 mm (27,6 in)

BenchTop Extraction Arm FX2 50 Original

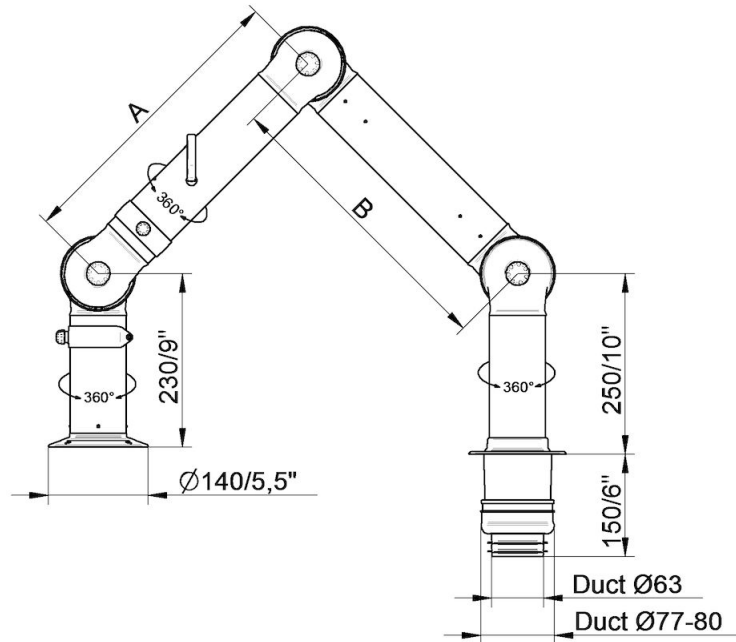

Part number: 70600344
 Max. working radius: 630 mm (24,8 in)
 A: 400 mm (15,7 in)
 B: -

• FX2-ORIG-D50-L1100-Down-Through
 Part number: 70600744
 Max. working radius: 1030 mm (40,5 in)
 A: 400 mm (15,7 in)
 B: 400 mm (15,7 in)

• FX2-ORIG-D50-L1500-Down-Through
 Part number: 70601144
 Max. working radius: 1430 mm (56,3 in)
 A: 500 mm (19,7 in)
 B: 700 mm (27,6 in)

BenchTop Extraction Arm FX2 50 Original

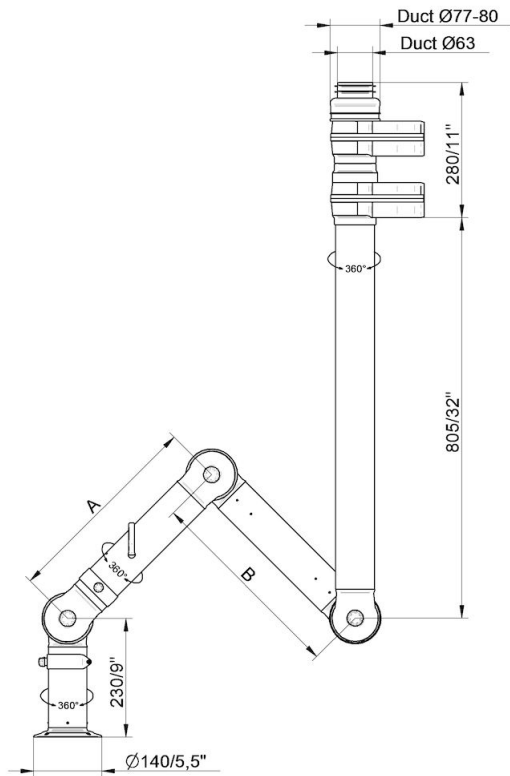

- FX2-ORIG-D50-L700-Up-PLUS
Part number: 70600244
Max. working radius: 630 mm (24,8 inch)
A: 400 mm (15,7 in)
B: -

- FX2-ORIG-D50-L1100-Up-PLUS
Part number: 70600544
Max. working radius: 1030 mm (40,5 in)
A: 400 mm (15,75in)
B: 400 mm (15,7 in)

- FX2-ORIG-D50-L1500-Up-PLUS
Part number: 70600944
Max. working radius: 1430 mm (56,3 in)
A: 500 mm (19,7 in)
B: 700 mm (27,6 in)

BenchTop Extraction Arm FX2 50 Original

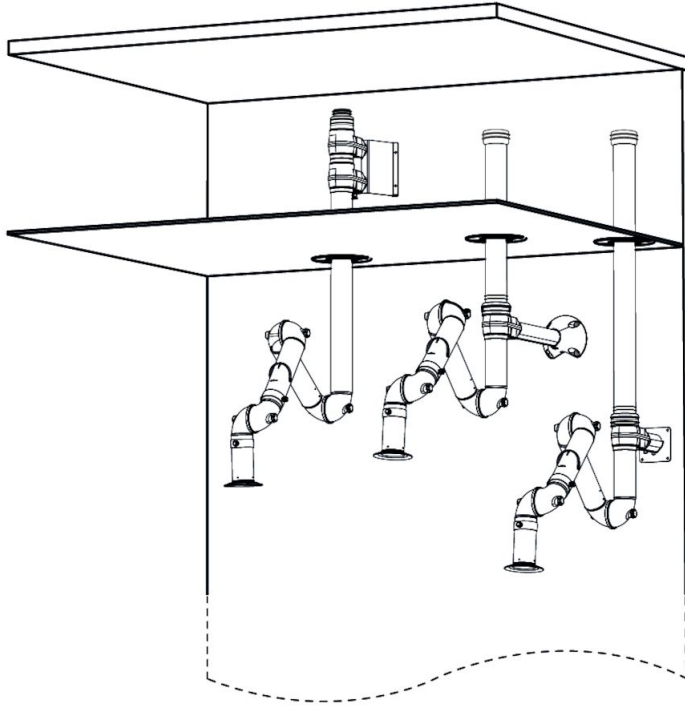

Ceiling mounting example:

Left: FX2-Up-Low arm with following accessories:

- FX-Classic bracket
- FX-Cut2fit extension-L1100
- FX2-Alu duct
- FX2-Duct connector-ORIG/CHEM-D75

Wall mounting examples:

Left: FX2-Up-PLUS arm with following accessories:

- FX2-Wall-P BRKT kit-D-50/75/100-L190
- FX2-Ceiling cover plate-PLUS

Middle: FX2-Up-Low arm with following accessories:

- FX2-Bracket kit-D-50/75/100-L500
- FX2-Ceiling cover plate-PLUS
- FX2-Alu duct
- FX2-Duct connector-ORIG/CHEM-D75

Right: Up-Low arm with following accessories:

- FX2-Wall BRKT kit-Flat-L190-White
- FX2-Ceiling cover plate-PLUS
- FX2-Alu duct
- FX2-Duct connector-ORIG/CHEM-D75

BenchTop Extraction Arm FX2 50 Original

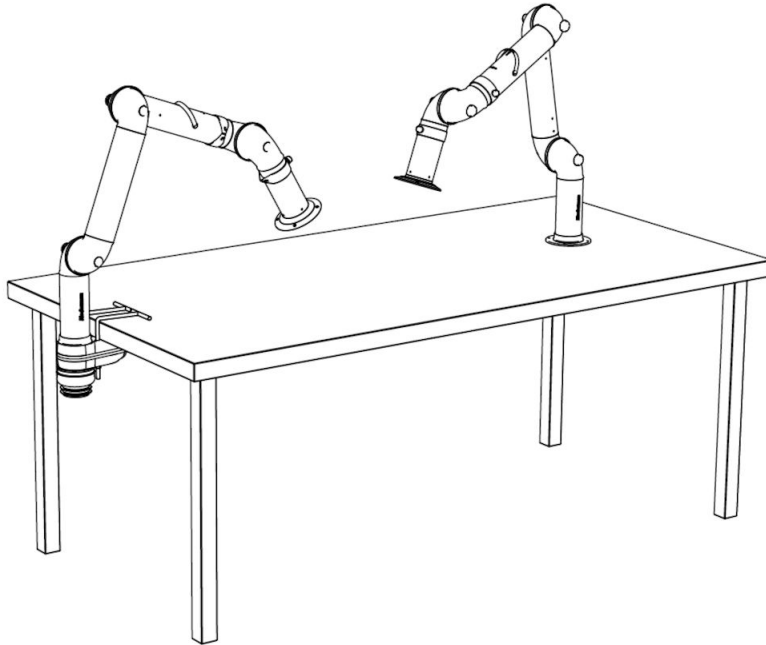

Bench mounting examples:

Left: FX2-Down-Low arm with following accessories:

-FX2-Bench bracket kit-D-50/75/100

Right: FX2-Down-Through arm

BenchTop Extraction Arm FX2 50 Original

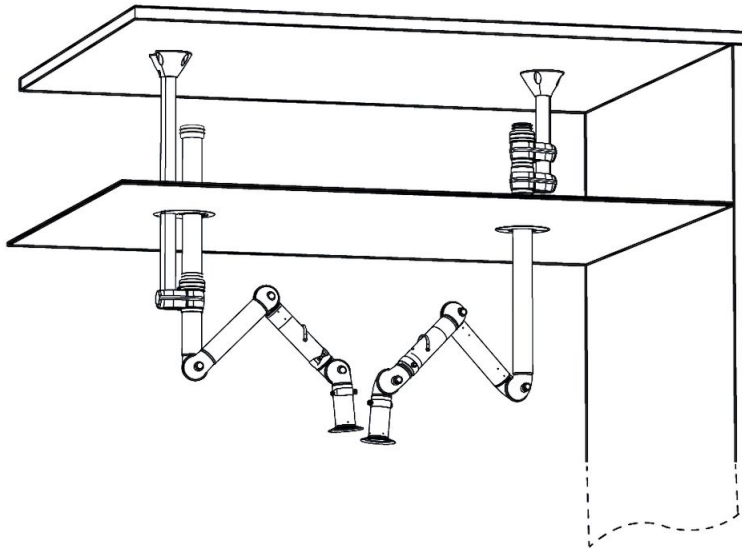

Ceiling mounting example:

Left: FX2-Up-Low arm with following accessories:

- FX-Classic bracket
- FX-Cut2fit extension-L1100
- FX2-Alu duct
- FX2-Duct connector-ORIG/CHEM-D75
- FX-Ceiling cover plate

Right: FX2-Up-PLUS arm with following accessories:

- FX2-Bracket kit-D-50/75/100-L500
- FX2-Ceiling cover plate-PLUS

BenchTop Extraction Arm FX2 50 Original

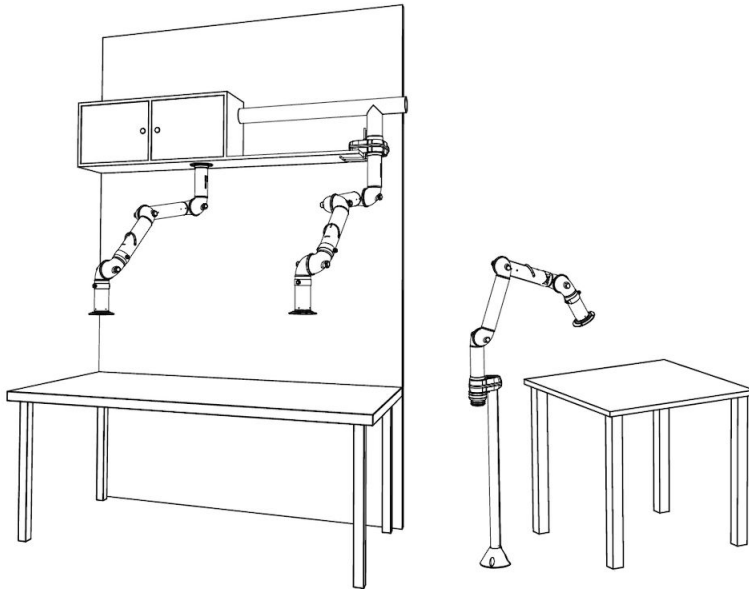

Bench mounting examples:

Other mounting examples:

Left: Over bench cabinet mounting with FX2-Up/Down-Through arm

Middle: Shelf mounting with FX2-Up-Low arm and following accessories:

-FX2-Bench bracket kit

Right: Floor mounting with FX2-Up-Low arm and following accessories:

-FX-Classic bracket

-FX-Cut2fit extension-L1100