

600A, konfigurierbar

En kraftig støvopsamler for støvsugning over lange horisontale og vertikale afstande.



Modulets konfiguration svarer til 600 A, som er beregnet til de tungeste applikationer, f.eks. håndtering af slibende og tungt materiale. Enhedens robusthed og strømmen fra den pålidelige ejektor gør enheden yderst velegnet til applikationer hvor almindelige industrielle støvsugere ikke kan anvendes. For eksempel til opsamling af sandblæsemateriale i blæsehaller, genanvendelse af sand på støberier osv.

Enheden kan konfigureres til at opfylde dine specifikke behov. Forskellige ejektorer kan anvendes afhængig af behov men også tilgængeligheden af trykluft. Ejektoren kan placeres på en stationær silo med filter.

Forskellige udløbsventiler kan monteres på siloen for nem udtømmning af det opsamlede materiale. Ved håndtering af større mængder, anbefaler Nederman at der anvendes en forudskiller før vakuumentheden.

For at konfigurere din 600 A model, skal du vælge ejektormodul, filtermodul, silomodul and tømmeventil iht. nedenstående.

1. Vælg ejektormodul afhængig af krævet vakuum og luftmængde.
2. Vælg filtermodul afhængig af filter kapacitet.
3. Vælg silomodul.
4. Vælg tømmeventil.
5. Vælg rengøringsudstyr.

Vælg hvordan du vil styre din butterflyventil:

1. Elektrisk styret - du skal bruge en namur ventil, magnetventil anbefalet for den valgte ejektor størrelse og en styreboks.
2. Trykluftstyret - du skal bruge en namur ventil.

Slange for trykluft til namur ventilen leveres ikke af Nederman.

Sørg for at alle krav til modulet er opfyldt. Højden på din konfiguration afhænger af hvilket filtermodul og ben du vælger.

- Robust og effektivt selvrensende filter
- Meget kraftig ejektor til levering af nødvendigt vakuum
- Velegnet til tungt/slibende materiale
- Styring med mange forskellige funktioner findes som tilbehør

Produkt navn	600A, konfigurierbar
Metode for filterrensning	Trykluft
Applikation	Granulat, Grit, Spån, Støv
Type af filter	Stavfilter
Antal filter	70
Indløb	Ø76 mm



Granulat





Grit

Spån

Støv



600A, konfigurierbar

Billede	Beskrivelse	Trykluftbehov	Maks. luftmængde (m ³ /h)	Noise level (dB(A))	Max vaccum (kPa)	Vægt (kg)	Model
	NE64, ejektormodul med S200 låg og 2 lynkoblinger	4,3 Nm ³ /min @ 7 bar	330 Nm ³ /h	77	-68	18	43051000*
	Silo S200 with plastic fasteners and abrasion plate. Conical 76mm inlet.					40	43440023
	Triangular frame for silo S200						43752001
	Leg straight 1500 mm						43756001**
	Leg straight 2200 mm						43756100**
	Stay-tube for legs L > 2200 mm						43757001***
	NE74, ejektormodul med S200 låg og 2 lynkoblinger	5,3 Nm ³ /min @ 7 bar	318 Nm ³ /h	75	-78	18	43051001*
	NE76, Ejectormodule with S200 lid and 2 quick couplings	5,4 Nm ³ /min @ 7 bar	690 Nm ³ /h	78	-48	18	43051002****
	NE96, Ejectormodule with S200 lid and 2 quick couplings	8,6 Nm ³ /min @ 7 bar	660 Nm ³ /h	78	-68	18	43051003****
	Filtermodule NCF, 5,25 m ² filterarea, I S200 Vyon F. MFC					55	43164101





















*Recommended with filtermodule 43162101

**Each configuration needs the quantity of three legs, so to get a complete product you need to order three pieces of chosen number

***To be used with 43756100, order three pieces

****Recommended with filtermodule 43164101

600A, konfigurierbar

Tilbehør		Artikelnummer
	Pneumatically operated butterfly discharge valve	43630500*
	Discharge valve manual	43630001**
	Pinch valve DN65	43632001
	Manually operated butterfly discharge valve	43630400*
	Pinch valve DN80	43632100
	Pinch valve DN100	43632200
	Discharge valve with counterweight	43630200**
	Discharge valve, pneumatically operated	43630100**
	Discharge valve Linatex d100 set with reducer for flange	43630300
	Bagholder for 43630200 or 43631001	43640001
	Bagholder for 43630100, for pneumatic discharge valve	43640003***
	Plastic bag S50 - 25pcs 630x800	43650104
	Bagholder big bag with pneumatically operated discharge valve	43640201
	Bagholder for big bag, MFC	43640217****
	Control S for NE 22-76	43220026
	Control S for NE86-96	43222008
	Control S for NE 22-76	43220001
	Electrical Control system for ejector NE 86	43222001
	Mountingplate for controlbox, S200	43690001
	Control system for ejectors	43220034
	Level control for silo continuous feed out	43251001
	Slange PU12-51 L=10m	43832600

600A, konfigurierbar

Tilbehør		Artikelnummer
	Slange PU12-51 L=5m	43832500
	Slange PU12-51 L=20m	43832300
	Slange PU12-51 L=7,5m med kobling	43832102*****
	Slange PU12-51 L=10m med kobling	43832200*****
	Slange PU12-63 L=5m	43833200
	Slange PU12-63 L=10m	43833001
	Slange PU12-63 L=20m	43833100
	Slange PU12-76 L=10m	43834200
	Slange PU12-76 L=20m	43834300
	Rengøringsudstyr komplet for gulv. Mundstykke med Ø38 hjul og gummilæber. Bredde 500mm. Ø51mm tilkobling	42932100*****
	Gulvrengøringsæt, bredde 400 mm uden hjul for vådsugning ø51, med børster	42932800*****
	Rengøringsudstyr komplet for gulv. Mundstykke med Ø65 hjul og gummilæber. Bredde 400mm. Ø51mm tilkobling	42932300*****
	Gulvmundstykke d51/500	43840150*****
	Gulvmundstykke d51/400/65	43840250*****
	Børste gulvmundstykke d51/400	43840550*****
	Håndmundstykke, hård børste ø51	43860001*****
	Tandet mundstykke ø51	43861001*****
	Konisk mundstykke ø51	43862001*****
	Vinklet støvsugerør d51 antistatisk	43842150*****
	Støvsugerør d51 PEHD-el 1m	43842001*****
	Bulkmundstykke d51 m/håndtag	43850150*****
	Bulkmundstykke d51	43850001*****

600A, konfigurierbar

	Tilbehør	Artikelnummer
	Skrabemundstykke ø51 l=1000	43851150*****
	Skrabemundstykke ø51 l=500	43851050*****
	Spån mundstykke Ø 50 mm	40150030*****
	Gulvmundstykke d63/500	43840400*****
	Bulkmundstykke d63	43850050*****
	Falskluftmundstykke ø63, luge	43850051*****
	Bulkmundstykke d63 m/håndtag	43850200*****
	Skrabemundstykke ø63 L = 1000	43851200*****
	Vinklet støvsugerør aluminium d63	43843050*****
	Drejeled stål d63	43843100*****
	Støvsugerør aluminium d63	43843001*****
	Skrabemundstykke ø63 L = 500	43851100*****
	Bulkmundstykke d76	43850100*****
	Bulkmundstykke d76 m/håndtag	43850250*****
	Skrabemundstykke ø76 l=1000	43851250*****
	Slangereduktion, konisk ø76-63	43880350
	Reduktion konisk ø76-51	43880300
	Slangereduktion, konisk ø63-51	43880250
	Slangetilslutning ø63	43880100
	Slangetilslutning ø50	43880050
	Bin Level indicator (BL) EX	40375269
	Slangetilslutning konisk ø76	43880150

600A, konfigurerbar

Tilbehør		Artikelnummer
	Gulvmundestykke d63/600	43840450*****

*Ø125mm Housing in NBR, Epoxy coated cast iron and flap/sleeve i stainless steel. Temp range -20C to +120C. Height - 110 mm (260 mm in open position)

**Ø150mm Housing and flap in PA. Temp range -20C to +40C. Height - 155 mm (240 mm in open position)

***Recommended with 43630100

****Can be used with valves 43630300, 43632001, 43632100, 43630201

*****Koblinger inkluderet, Ø 51 mm

*****Couplings included, Ø 51 mm

*****ATEX - Velegnet til brændbart støv (zone 20, 21, 22). Sikre jording til udsugningsenheden. Bør ikke anvendes i brændbare gas atmosfærer eller ved udsugning af eksplosive materialer.

*****ATEX - Dette produkt er velegnet som rengøringsudstyr til brændbart støv med MIE (minimum tændenergi) > 1 mJ. Produktet skal jordes til udsugningsenheden. Bør ikke anvendes i brændbar gas atmosfære eller til udsugning af eksplosive materialer.

*****ATEX - Velegnet til brændbart støv (zone 20, 21, 22) og gas (zone 1, 2) i gruppe IIA, IIB og IIC. Sikre jording til udsugningsenheden. Bør ikke anvendes til udsugning af eksplosive materialer.

600A, konfigurierbar

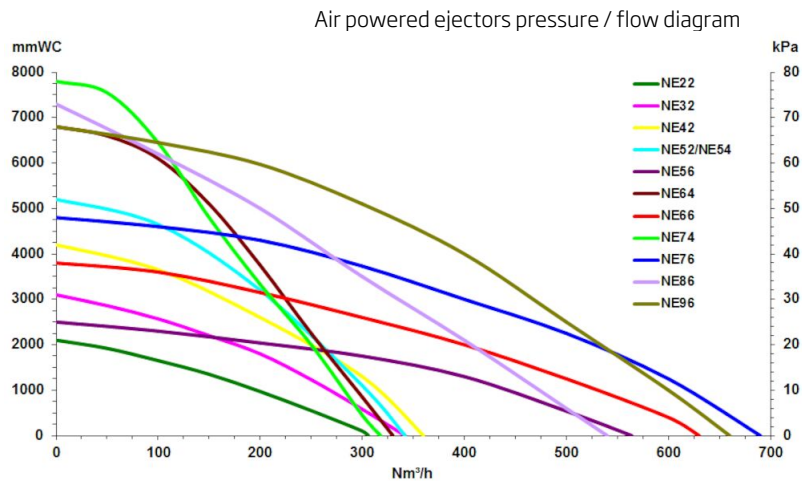

Air Powered ejectors

All performance data are based on 7 bar supply pressure

Ejector/Hose dimension	ø51mm	ø63mm	ø76mm
NE64	2	2,4	N/A
NE74	2,3	2,7	N/A
NE76	1,7	2,7	3,6
NE96	2,6	3,6	4,9

Capacity (tonne/hour) with Blasting media 2,4kg/liter and 20m hose

600A, konfigurierbar

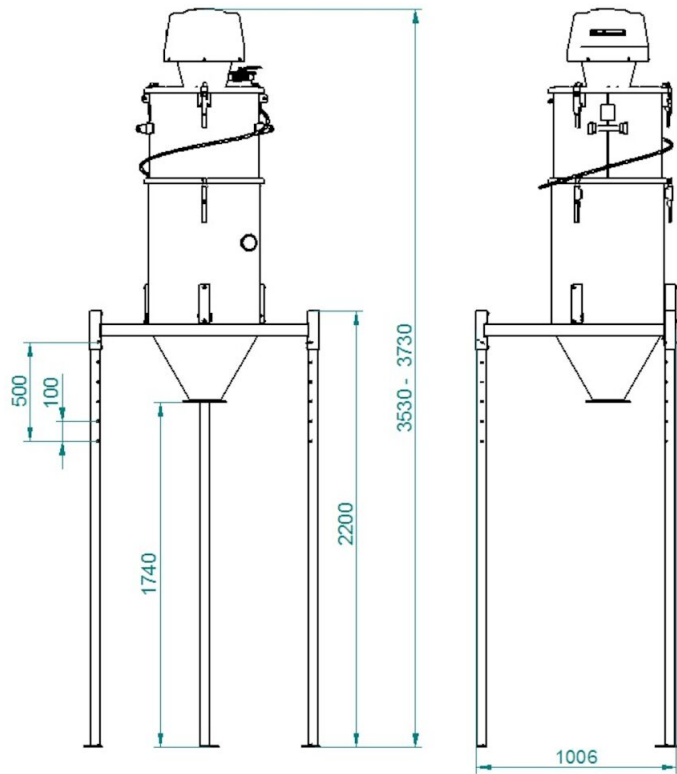

Dimensions with 2200 mm legs

600A, konfigurierbar

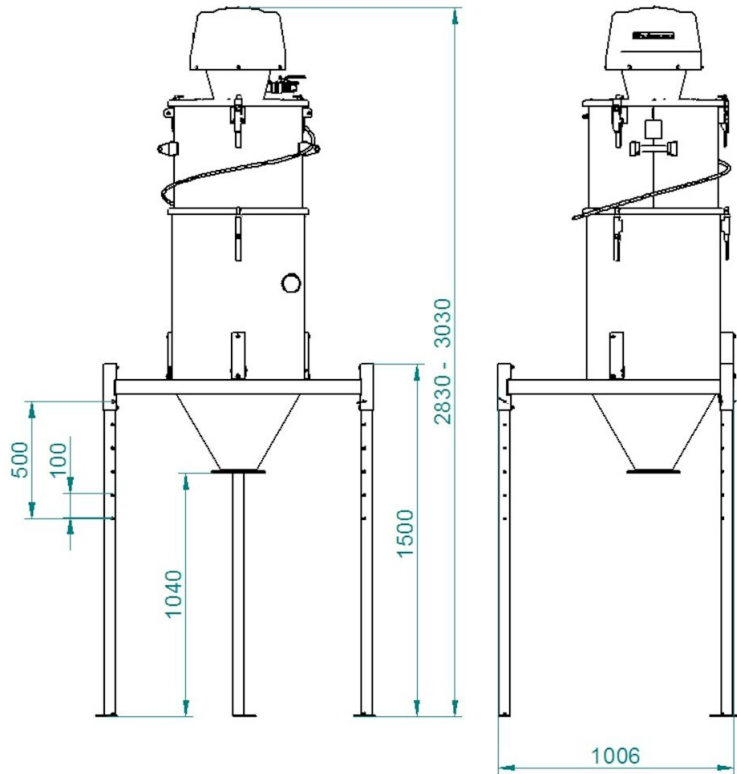

Dimensions with 1 500 mm legs