

## 600A, Configurable

A powerful dust collector, for suction over long horizontal and vertical distance

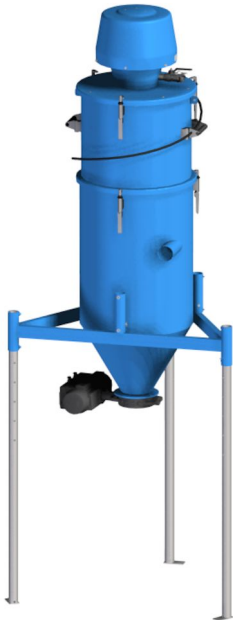

The configuration of modules will be similar to 600A which are aimed for the toughest applications, for example handling a lot of abrasive and heavy material. The robustness of the unit and the power from the reliable ejector makes the unit very suitable for many applications where many industrial vacuum cleaners can not be used. For example to collect blasting material in blasting hall, sand recovery in foundries etc.

Your unit can be configured to meet your specific demands. Different ejectors can be used depending on the demand but also the availability of compressed air. The ejector can be placed on a stationary silo with filter.

A range of different discharge valves that can be fitted to the silo for easy discharge of the collected material.

If handling larger quantities of material, Nederman recommends using a pre separator before the vacuum unit.

To configure your 600A you may only choose ejectormodule, filtermodule, silomodule and discharge valve listed in this document and with mfc (module for configuration) in title.

1. Select ejectormodule depending on required vacuum and air flow.
2. Select filtermodule depending on filter capacity.
3. Select silomodule.
4. Select discharge valve.
5. Select cleaning equipment.

Choose how to control your butterfly valve:

1. Electric controlled - You need a namur valve, solenoid valve recommended for the ejector size you choose and a control box.
2. Air controlled - You need a namur valve.

Hose for air supply to the namur valve is not supplied by Nederman.

Ensure that all requirements for the modules are met. The height of your configuration is depending on what filtermodule and legs you choose.

- **Robust and efficient self-cleaning filter**
- **Very powerful and reliable ejector as vacuum producer**
- **Suitable for heavy and/or abrasive material**
- **Control system with many different functions is available as an accessory**

<b>Product name</b>	600A, Configurable
<b>Filter cleaning method</b>	[CompressedAir]
<b>Application</b>	[granulate], [grit], [swarf], [dust]
<b>Filter type</b>	[NCF]
<b>Number of filter elements</b>	70



Granulate

Grit









Swarf

Dust



# 600A, Configurable

## 600A, Configurable

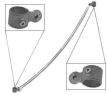
[Image]	Description	Compressed air requirement	Max airflow (m³/h)	Noise level (dB(A))	Max vacuum (kPa)	Weight (kg)	[model]
	NE64, Ejectormodule with S200 lid and 2 quick couplings	4,3 Nm3/min @ 7 bar		77	-68	18	43051000 *
	NE74, Ejectormodule with S200 lid and 2 quick couplings	5,3 Nm3/min @ 7 bar	318 Nm3/h	75	-78	18	43051001 *
	NE76, Ejectormodule with S200 lid and 2 quick couplings	5,4 Nm3/min @ 7 bar	690 Nm3/h	78	-48	18	43051002 **
	NE96, Ejectormodule with S200 lid and 2 quick couplings	8,6 Nm3/min @ 7 bar	660 Nm3/h	78	-68	18	43051003 ***
	Filtermodule NCF, 3,15 m2 filterarea, I S200 Vyon F. MFC					40	43162101
	Filtermodule NCF, 5,25 m2 filterarea, I S200 Vyon F. MFC					55	43164101
	Triangular frame for silo S200						43752001
	Leg straight 1500 mm						43756001****
	Leg straight 2200 mm						43756100****
	Stay-tube for legs L>2200 mm						43757001*****

\*Recommended with filtermodule 43162101

\*\*Recommended with filtermodule 43164101

\*\*\*Recommended with filtermodule 43164101

\*\*\*\*Each configuration needs the quantity of three legs, so to get a complete product you need to order three pieces of chosen number

\*\*\*\*\*To be used with 43756100, order three pieces

## 600A, Configurable

	[accessory]	[partno]
	Discharge valve manual	43630001*
	Pinch valve DN65	43632001
	Manually operated butterfly discharge valve	43630400**
	Pinch valve DN80	43632100
	Pinch valve DN100	43632200
	Discharge valve with counterweight	43630200*
	Discharge valve, pneumatically operated	43630100*
	Discharge valve Linatex d100 set with reducer for flange	43630300
	Bagholder for 43630200 or 43631001	43640001
	Bagholder for 43630100	43640003***
	Plastic bag S50 - 25pcs 630x800	43650104
	Bagholder big bag with pneumatically operated discharge valve	43640201
	Bagholder for big bag, MFC	43640217****
	Timer electrical control for ejector NE 22-76, without control box. Mounted on the compressed air connection. (Suction time: 0 - 15 min, Discharge time: 0-15 sek)	43220026
	Timer electrical control for ejector NE 86-96, without control box. Mounted on the compressed air connection. (Suction time: 0 - 15 min, Discharge time: 0-15 sek)	43222008
	Electrical control system for ejectors NE 22-76. (Suction time: 0-5 min, Discharge time: 0-15 sek)	43220001
	Electrical Control system for ejector NE 86 (Suction time: 0-5 min, Discharge time: 0-15 sek)	43222001
	Mountingplate for 43220001 and 43212001	43690001
	Control system for ejectors	43220034
	Level control for silo continuous feed out	43251001
	Hose PU12 Ø 51 L=10m	43832600
	Hose PU12 Ø 51 L=5m	43832500

## 600A, Configurable

	[accessory]	[partno]
	Hose PU12 Ø 51 L=20m	43832300
	Hose PU12 Ø 51 L=7,5m w. couplings	43832102*****
	Hose PU12 Ø 51 L=10m w. couplers	43832200*****
	Hose PU12 Ø 63 L=5m	43833200
	Hose PU12 Ø 63 L=10m	43833001
	Hose PU12 Ø 63 L=20m	43833100
	Hose PU12 Ø 76 L=10m	43834200
	Hose PU12 Ø 76 L=20m	43834300
	Floor cleaning equipment width 500 mm with small nylon wheels Ø51	42932100*****
	Floor cleaning equipment width 400 mm without wheels for dry suction Ø51	42932800*****
	Floor cleaning equipment width 400 mm with large rubber wheels Ø51	42932300*****
	Floor nozzle, width 500 mm with small nylon wheels, Ø51	43840150*****
	Floor nozzle, width 400 mm with large rubber wheels, Ø51	43840250*****
	Floor nozzle width 400 mm without wheels for dry suction, Ø51	43840550*****
	Hand nozzle, hard brush Ø90mm, Ø51	43860001*****
	Toothed nozzle width 130 mm, Ø51	43861001*****
	Cone nozzle Length 250 mm, Ø51	43862001*****
	Elbow pipe, Ø51 mm	43842150*****
	Cleaning pipe, length 1100 mm, Ø51 mm	43842001*****
	Bulk nozzle for floor length 1200 mm	43850150*****
	Bulk nozzle Length 910 mm	43850001*****
	Scraper nozzle, length: 1000 mm Ø51	43851150*****

## 600A, Configurable

	[accessory]	[partno]
	Scraper nozzle, length: 500 mm Ø51	43851050*****
	Steel swarf nozzle, Ø50 mm, Silenced inlet	40150030*****
	Floor suction head width 500mm, Ø63	43840400*****
	Bulk nozzle length 910 mm, galvanized, Ø63	43850050*****
	Bulk nozzle length 910 mm for swivel (43843100), d63	43850051*****
	Bulk nozzle for floor, length 1200 mm	43850200*****
	Scraper hand nozzle, length 1000 mm	43851200*****
	Suct pipe bend alum d63	43843050*****
	Swivel steel d63	43843100*****
	Suction pipe aluminium Ø63	43843001*****
	Scraper hand nozzle, length 500 mm	43851100*****
	Bulk nozzle length 910 mm, d76, galvanized	43850100*****
	Bulk nozzle with handle	43850250*****
	Scraper hand nozzle, length 1000 mm	43851250*****
	Reducer conical d76-63, Acid stainless steel	43880350
	Reducer conical d76-51, Acid stainless steel	43880300
	Hose red conical d63-51	43880250
	Hose connector d63	43880100
	Hose connector d50	43880050
	Bin Level indicator (BLI) EX	40375269
	Hose joint d76, Acid stainless steel	43880150
	Floor suct head d63/600	43840450*****

## 600A, Configurable

*\*Ø150mm Housing and flap in PA. Temp range -20C to +40C. Height: 155 mm (240 mm in open position)*

*\*\*Ø125mm Housing in NBR, Epoxy coated cast iron and flap/sleeve i stainless steel. Temp range -20C to +120C. Height: 110 mm (260 mm in open position)*

*\*\*\*Recommended with 43630100*

*\*\*\*\*Can be used with valves 43630300, 43632001, 43632100, 43630201*

*\*\*\*\*\*Couplings included, Ø 51 mm*

*\*\*\*\*\*ATEX: Suitable for combustible dust with MIE (minimum ignition energy) < 1mJ. Ensure earthing to extraction unit. Not to be used in combustible gas atmospheres or extraction of explosive materials*

*\*\*\*\*\*ATEX: This product is suitable to be used as cleaning equipment for combustible dusts with MIE (minimum ignition energy) >1 mJ. Product is to be properly earthed to the extraction unit. Not for usage in combustible gas atmospheres or extraction of xplosive materials.*

*\*\*\*\*\*ATEX: Suitable for combustible dust (zone 20,21,22) and gas (zone 1,2) of group IIA , IIB and IIC. Ensure earthing to extraction unit. Not to be used for extraction of explosive materials*

## 600A, Configurable

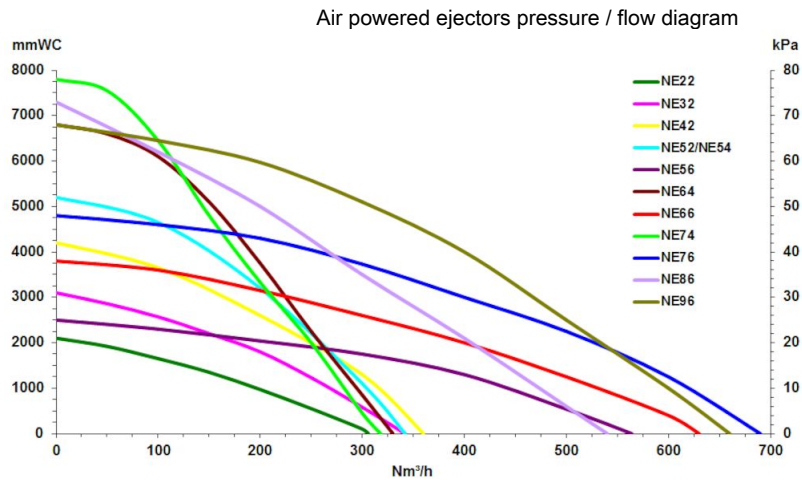

Air Powered ejectors

All performance data are based on 7 bar supply pressure

Ejector/Hose dimension	ø51mm	ø63mm	ø76mm
NE64	2	2,4	N/A
NE74	2,3	2,7	N/A
NE76	1,7	2,7	3,6
NE96	2,6	3,6	4,9

Capacity (tonne/hour) with Blasting media 2,4kg/liter and 20m hose



## 600A, Configurable

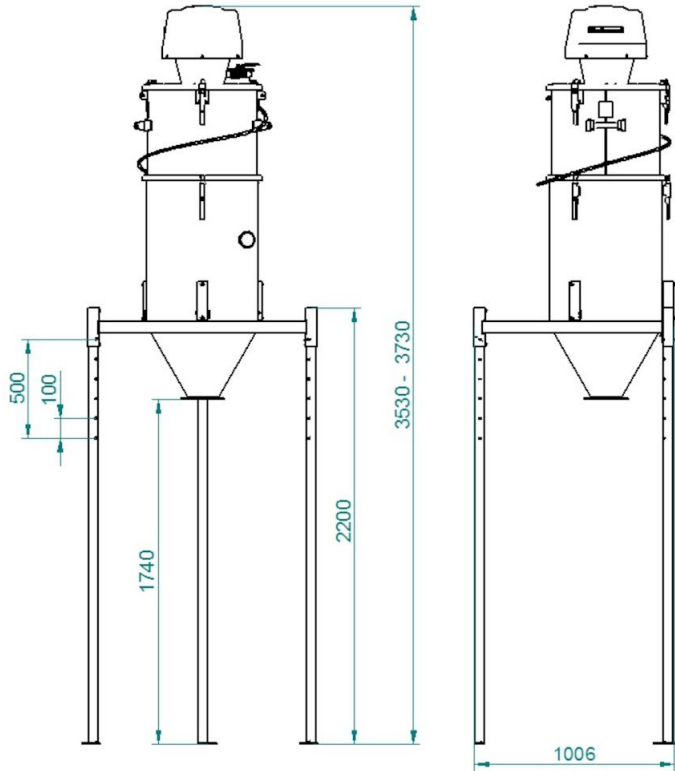

Dimensions with 2200 mm legs

# 600A, Configurable

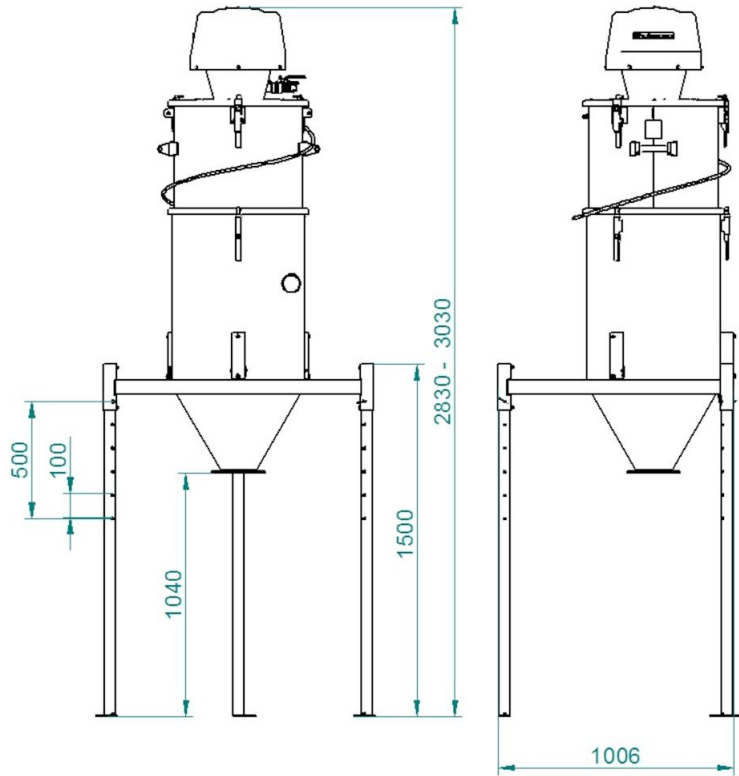

Dimensions with 1 500 mm legs