

600A, Configurable

A powerful dust collector, for suction over long horizontal and vertical distance

600A, Configurable

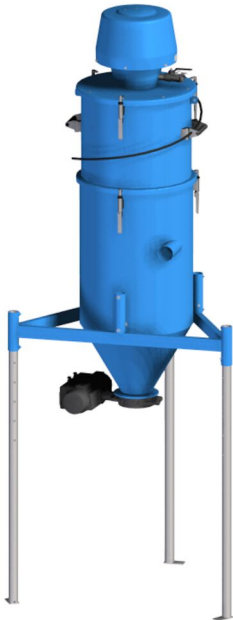

The configuration of modules will be similar to 600A which are aimed for the toughest applications, for example handling a lot of abrasive and heavy material. The robustness of the unit and the power from the reliable ejector makes the unit very suitable for many applications where many industrial vacuum cleaners can not be used. For example to collect blasting material in blasting hall, sand recovery in foundries etc.

Your unit can be configured to meet your specific demands.

Different ejectors can be used depending on the demand but also the availability of compressed air. The ejector can be placed on a stationary silo with filter.

A range of different discharge valves that can be fitted to the silo for easy discharge of the collected material.

If handling larger quantities of material, Nederman recommends using a pre separator before the vacuum unit.

To configure your 600A you may only choose ejectormodule, filtermodule, silomodule and discharge valve listed in this document and with mfc (module for configuration) in title.

1. Select ejectormodule depending on required vacuum and air flow.
2. Select filtermodule depending on filter capacity.
3. Select silomodule.
4. Select discharge valve.
5. Select cleaning equipment.

Choose how to control your butterfly valve:

1. Electric controlled - You need a namur valve, solenoid valve recommended for the ejector size you choose and a control box.
2. Air controlled - You need a namur valve.

Hose for air supply to the namur valve is not supplied by Nederman.

Ensure that all requirements for the modules are met. The height of your configuration is depending on what filtermodule and legs you choose.

- Robust and efficient self-cleaning filter
- Very powerful and reliable ejector as vacuum producer
- Suitable for heavy and/or abrasive material
- Control system with many different functions is available as an accessory

Nom du produit	600A, Configurable
Méthode de décolmatage	[CompressedAir]
Application	Granulé, Abrasif, Copeau, Poussière
Type de filtre	Filtre à bougie
Nombre d'éléments filtrants	70
Inlet	Ø76 mm



600A, Configurable

Granulé Abrasif Copeau Poussière

600A, Configurable

[image]	Nom de la fiche technique	Compressed air requirement	Max airflow (m³/h)	Volume sonore (dB(A))	Max vacuum (kPa)	Poids (kg)	[model]
	NE64, module éjecteur avec couvercle S200 et 2 raccords rapides	4,3 Nm³/min @ 7 bar	330 Nm³/h	77	-68	18	43051000*
	Silo S200 avec fixations en plastique et plaque abrasive. Entrée conique 76 mm.					40	43440023
	Cadre triangulaire pour silo S200						43752001
	Pied droit 1 500 mm						43756001**
	Pied droit 2 200 mm						43756100**
	Tube d'ancrage pour pieds L > 2 200 mm						43757001***
	NE74, module éjecteur avec couvercle S200 et 2 raccords rapides	5,3 Nm³/min @ 7 bar	318 Nm³/h	75	-78	18	43051001*
	NE76, module éjecteur avec couvercle S200 et 2 raccords rapides	5,4 Nm³/min @ 7 bar	690 Nm³/h	78	-48	18	43051002****
	NE96, module éjecteur avec couvercle S200 et 2 raccords rapides	8,6 Nm³/min @ 7 bar	660 Nm³/h	78	-68	18	43051003****
	Module filtrant NCF, 5,25 m² zone de filtrage, 1 S200 Vyon F, MFC					55	43164101





















*Recommandé avec le module de filtre 43162101

**Chaque configuration nécessite trois pieds. Ainsi, pour obtenir le produit entier souhaité, vous devez commander trois éléments du nombre choisi

***À utiliser avec 43756100, commander trois pièces

****Recommandé avec le module de filtre 43164101













600A, Configurable

	[accessory]	[partno]
	Vanne papillon de décharge pneumatique	43630500*
	Vanne de décharge manuelle	43630001**
	Vanne d'étranglement DN65	43632001
	Vanne papillon de décharge manuelle	43630400*
	Vanne d'étranglement DN80	43632100
	Vanne d'étranglement DN100	43632200
	Vanne de décharge avec contrepoids	43630200**
	Vanne de décharge, pneumatique	43630100**
	Kit vanne de décharge Linatex d100 avec réducteur pour bride	43630300
	Support sac pour 43630200 ou 43631001	43640001
	Support sac pour 43630100, pour vanne de décharge pneumatique	43640003***
	Sac en plastique S50 - 25 pcs 630x800	43650104
	Support grand sac avec vanne de décharge pneumatique	43640201
	Bagholder for big bag, MFC	43640217****
	Commande S for NE 22-76	43220026
	Commande Sfor NE 86	43222008
	Commande S pour NE 22-76	43220001
	Système de commande électrique pour éjecteur NE 86.	43222001
	Plaque de montage pour Controlbox, S200	43690001
	Control system for ejectors	43220034
	Indicateur de niveau pour silo enlèvement continu	43251001
	Tuyau PU12 Ø 51 L=10m	43832600

600A, Configurable

	[accessory]	[partno]
	Tuyau PU12 Ø 51 L=5m	43832500
	Tuyau PU12 Ø 51 L=20m	43832300
	Tuyau PU12 Ø 51 L=7,5 m a. raccords	43832102*****
	Tuyau PU12 Ø 51 L=10 m a. raccords	43832200*****
	Tuyau PU12 Ø 63 L=5m	43833200
	Tuyau PU12 Ø 63 L=10m	43833001
	Tuyau PU12 Ø 63 L=20m	43833100
	Tuyau PU12 Ø 76 L=10m	43834200
	Tuyau PU12 Ø 76 L=20m	43834300
	Équipement de nettoyage du sol largeur 500 mm avec petites roues en nylon Ø51	42932100*****
	Équipement de nettoyage du sol largeur 400 mm sans roue pour aspiration sèche Ø51	42932800*****
	Équipement de nettoyage du sol largeur 400 mm avec grandes roues en nylon Ø51	42932300*****
	Buse plancher, largeur 500 mm avec petites roues en nylon, Ø51	43840150*****
	Buse plancher, largeur 400 mm avec grandes roues en caoutchouc, Ø51	43840250*****
	Buse sol largeur 400 mm sans roue pour aspiration sèche, Ø51	43840550*****
	Buse manuelle, brosse rigide Ø90 mm, Ø51	43860001*****
	Buse dentée largeur 130 mm, Ø51	43861001*****
	Buse conique longueur 250 mm, Ø51	43862001*****
	Tuyau coudé, Ø51 mm	43842150*****
	Conduite de nettoyage, longueur 1 100 mm, Ø51 mm	43842001*****
	Buse en vrac pour sol avec poignée longueur 1 200 mm, Ø51 mm	43850150*****
	Buse en vrac longueur 910 mm, Ø51	43850001*****

600A, Configurable

	[accessory]	[partno]
	Buse racleur, longueur : 1 000 mm Ø51	43851150*****
	Buse racleur, longueur : 500 mm Ø51	43851050*****
	Buse à copeaux acier, Ø50 mm, entrée silencieux	40150030*****
	Tête d'aspiration sol largeur 500 mm, Ø63	43840400*****
	Buse en vrac longueur 910 mm, Ø63	43850050*****
	Buse en vrac longueur 910 mm pour rotule (43843100), Ø63	43850051*****
	Buse en vrac pour sol, longueur 1 200 mm, Ø63 mm	43850200*****
	Buse manuelle de racleur, longueur 1000 mm, Ø63	43851200*****
	Conduite d'asp. coudé alum d63	43843050*****
	Rotule acier d63	43843100*****
	Conduite d'aspiration pipe aluminium Ø63	43843001*****
	Buse manuelle de racleur, longueur 500 mm, Ø63	43851100*****
	Buse en vrac longueur 910 mm, d76, galvanisée	43850100*****
	Buse en vrac avec poignée, Ø76	43850250*****
	Buse manuelle de racleur, longueur 1 000 mm, Ø76	43851250*****
	Réducteur conique d76-63, acier inoxydable, résistant aux acides	43880350
	Réducteur conique d76-51, acier inoxydable, résistant aux acides	43880300
	Tuyau rouge conique d63-51	43880250
	Connecteur de tuyau d63	43880100
	Connecteur de tuyau d50	43880050
	Indicateur de niveau poubelle (BLI) EX	40375269
	Raccord de tuyau d76, acier inoxydable résistant aux acides	43880150

600A, Configurable

[accessory]		[partno]
	Tête d'aspiration sol d63/600	43840450*****

*Ø125 mm boîtier en NBR, fonte revêtement époxy et clapet/manchon en acier inoxydable. Plage de temp. -20 °C à +120 °C. Hauteur - 110 mm (260 mm en position ouverte)

**Ø150 mm boîtier et clapet en PA. Plage de temp. -20 °C à +40 °C. Hauteur - 155 mm (240 mm en position ouverte)

***Recommandé avec 43630100

****Can be used with valves 43630300, 43632001, 43632100, 43630201

*****Raccords inclus, Ø 51 mm

*****ATEX - Convient pour la poussière combustible avec MIE (énergie minimale d'inflammation) < 1 mJ. Assurer la mise à la terre à l'unité d'aspiration Ne pas utiliser dans les atmosphères contenant des gaz combustibles ou pour l'aspiration de matière explosive

*****ATEX - Ce produit convient à une utilisation en tant qu'équipement de nettoyage pour les poussières combustibles avec une MIE (énergie minimale d'inflammation) > 1 mJ. Le produit doit être correctement relié à la terre à l'unité d'aspiration. Ne pas utiliser dans les atmosphères contenant des gaz combustibles ou pour l'aspiration de matière explosive

*****ATEX - Convient pour la poussière combustible (zone 20, 21, 22) et au gaz (zone 1,2) du groupe IIA, IIB et IIC. Assurer la mise à la terre à l'unité d'aspiration Ne pas utiliser pour l'aspiration de matière explosive

600A, Configurable

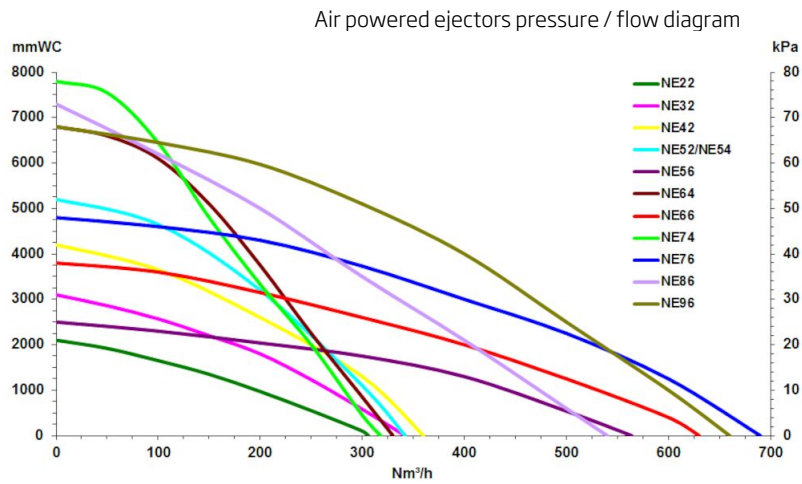

Air Powered ejectors

All performance data are based on 7 bar supply pressure

Ejector/Hose dimension	ø51mm	ø63mm	ø76mm
NE64	2	2,4	N/A
NE74	2,3	2,7	N/A
NE76	1,7	2,7	3,6
NE96	2,6	3,6	4,9

Capacity (tonne/hour) with Blasting media 2,4kg/liter and 20m hose

600A, Configurable

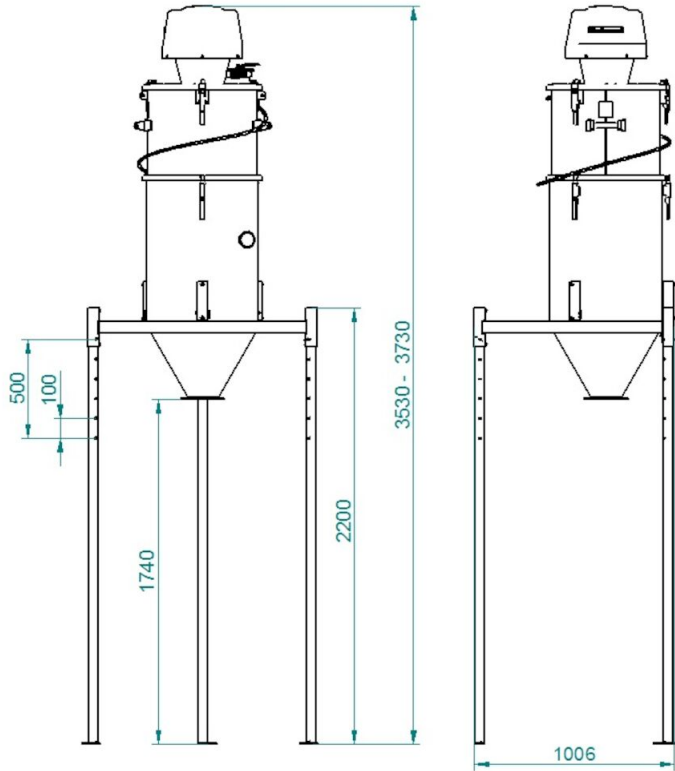

Dimensions with 2200 mm legs

600A, Configurable

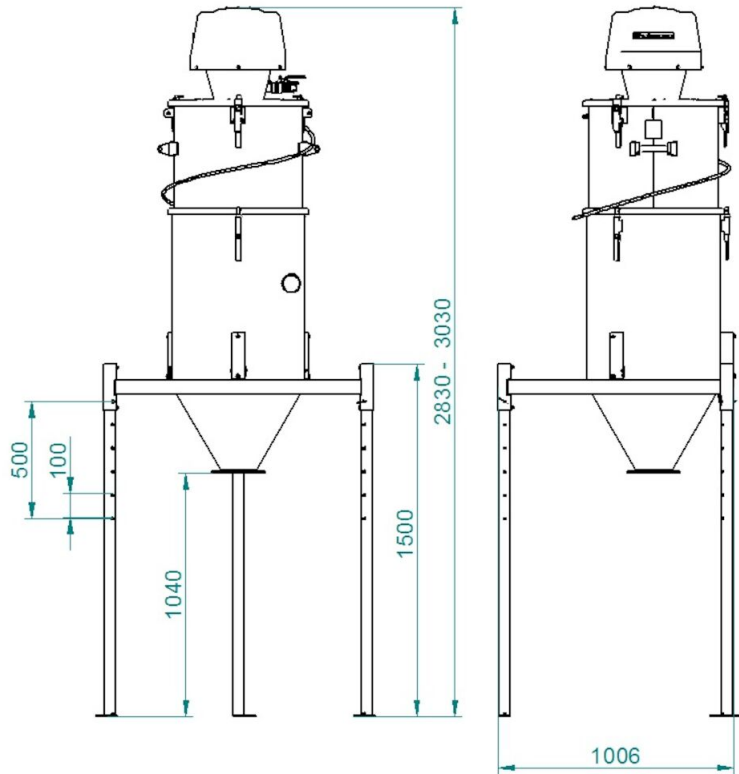

Dimensions with 1 500 mm legs