

# 600A, Configurable

A powerful dust collector, for suction over long horizontal and vertical distance

---

## 600A, Configurable



The configuration of modules will be similar to 600A which are aimed for the toughest applications, for example handling a lot of abrasive and heavy material. The robustness of the unit and the power from the reliable ejector makes the unit very suitable for many applications where many industrial vacuum cleaners can not be used. For example to collect blasting material in blasting hall, sand recovery in foundries etc.

Your unit can be configured to meet your specific demands.

Different ejectors can be used depending on the demand but also the availability of compressed air. The ejector can be placed on a stationary silo with filter.

A range of different discharge valves that can be fitted to the silo for easy discharge of the collected material.

If handling larger quantities of material, Nederman recommends using a pre separator before the vacuum unit.

To configure your 600A you may only choose ejectormodule, filtermodule, silomodule and discharge valve listed in this document and with mfc (module for configuration) in title.

1. Select ejectormodule depending on required vacuum and air flow.
2. Select filtermodule depending on filter capacity.
3. Select silomodule.
4. Select discharge valve.
5. Select cleaning equipment.

Choose how to control your butterfly valve:

1. Electric controlled - You need a namur valve, solenoid valve recommended for the ejector size you choose and a control box.
2. Air controlled - You need a namur valve.

Hose for air supply to the namur valve is not supplied by Nederman.

Ensure that all requirements for the modules are met. The height of your configuration is depending on what filtermodule and legs you choose.

- Robust and efficient self-cleaning filter
- Very powerful and reliable ejector as vacuum producer
- Suitable for heavy and/or abrasive material
- Control system with many different functions is available as an accessory









Produktnavn	600A, Configurable
Rengjøringsmetode, filter	[CompressedAir]
Bruksområde	[granulate], [grit], [swarf], Støv
Filtertype	Kuvertfilter
Antall filterelementer	70
Inlet	Ø76 mm



# 600A, Configurable

Granulate Grit Swarf Støv

## 600A, Configurable

Bilde	Navn på datablad	Compressed air requirement	Max airflow (m <sup>3</sup> /h)	Noise level (dB(A))	Max vaccum (kPa)	Vekt (kg)	Model
	NE64, Ejectormodule with S200 lid and 2 quick couplings	4,3 Nm <sup>3</sup> /min @ 7 bar	330 Nm <sup>3</sup> /h	77	-68	18	43051000*
	Silo S200 with plastic fasteners and abrasion plate. Conical 76mm inlet.					40	43440023
	Triangular frame for silo S200						43752001
	Leg straight 1500 mm						43756001**
	Leg straight 2200 mm						43756100**
	Stay-tube for legs L > 2200 mm						43757001***
	NE74, Ejectormodule with S200 lid and 2 quick couplings	5,3 Nm <sup>3</sup> /min @ 7 bar	318 Nm <sup>3</sup> /h	75	-78	18	43051001*
	NE76, Ejectormodule with S200 lid and 2 quick couplings	5,4 Nm <sup>3</sup> /min @ 7 bar	690 Nm <sup>3</sup> /h	78	-48	18	43051002****
	NE96, Ejectormodule with S200 lid and 2 quick couplings	8,6 Nm <sup>3</sup> /min @ 7 bar	660 Nm <sup>3</sup> /h	78	-68	18	43051003****
	Filtermodule NCF, 5,25 m <sup>2</sup> filterarea, I S200 Vyon F. MFC					55	43164101





















\*Recommended with filtermodule 43162101

\*\*Each configuration needs the quantity of three legs, so to get a complete product you need to order three pieces of chosen number

\*\*\*To be used with 43756100, order three pieces

\*\*\*\*Recommended with filtermodule 43164101



















## 600A, Configurable

Tilbehør		Artikelnummer
	Pneumatically operated butterfly discharge valve	43630500*
	Discharge valve manual	43630001**
	Pinch valve DN65	43632001
	Manually operated butterfly discharge valve	43630400*
	Pinch valve DN80	43632100
	Pinch valve DN100	43632200
	Discharge valve with counterweight	43630200**
	Discharge valve, pneumatically operated	43630100**
	Discharge valve Linatex d100 set with reducer for flange	43630300
	Bagholder for 43630200 or 43631001	43640001
	Bagholder for 43630100, for pneumatic discharge valve	43640003***
	Plastic bag S50 - 25pcs 630x800	43650104
	Bagholder big bag with pneumatically operated discharge valve	43640201
	Bagholder for big bag, MFC	43640217****
	Control S for NE 22-76	43220026
	Control S for NE86-96	43222008
	Control S for NE 22-76	43220001
	Electrical Control system for ejector NE 86	43222001
	Mountingplate for controlbox, S200	43690001
	Control system for ejectors	43220034
	Level control for silo continuous feed out	43251001
	Slange PU12 Ø 51 L=10 m	43832600

## 600A, Configurable

Tilbehør		Artikkelnummer
	Slange PU12 Ø 51 L=5m	43832500
	Slange PU12 Ø 51 L=20 m	43832300
	Slange PU12 Ø 51 L=7,5m med koblinger	43832102*****
	Slange PU12 Ø 51 L=10 m m/koblinger	43832200*****
	Slange PU12 Ø 63 L=5m	43833200
	Slange PU12 Ø 63 L=10 m	43833001
	Slange PU12 Ø 63 L=20 m	43833100
	Slange PU12 Ø 76 L=10 m	43834200
	Slange PU12 Ø 76 L=20 m	43834300
	Sugeutstyr komplett for gulv. Munnstykke med d38 hjul og gummilepper. Bredde 500mm. D51 tilkobling	42932100*****
	Sugeutstyr komplett for gulv. Uten hjul.Med børster. Bredde 400mm. D51 tilkobling	42932800*****
	Sugeutstyr komplett for gulv. Munnstykke med d65 hjul og gummilepper. Bredde 400mm. D51 tilkobling	42932300*****
	Gulvmunnstykke,bredde 500 mm med små nylonhjul	43840150*****
	Gulvmunnstykke,bredde 400 mm med store gummihjul	43840250*****
	Gulvmunnstykke bredde 400 mm uten hjul for tørrsuging	43840550*****
	Håndmunnstykke,hard børste Ø90 mm	43860001*****
	Tannet munnstykke bredde 130 mm	43861001*****
	Konisk munnstykke Lengde 250 mm	43862001*****
	Albuerør,Ø51 mm	43842150*****
	Rengjøringsrør,lengde 1100 mm,Ø51 mm	43842001*****
	Bulk munnstykke for gulv lengde 1200 mm	43850150*****
	Bulk munnstykke Lengde 910 mm	43850001*****

## 600A, Configurable

	Tilbehør	Artikkelnummer
	Skrapemunnstykke, lengde: 1000 mm	43851150*****
	Skrapemunnstykke, lengde: 500 mm	43851050*****
	Stålsponmunnstykke, Ø50 mm, dempet innløp	40150030*****
	Floor suction head width 500mm, Ø63	43840400*****
	Bulk munnstykke lengde 910 mm	43850050*****
	Bulk munnstykke lengde 910 mm for svivel	43850051*****
	Bulk munnstykke for gulv, lengde 1200 mm	43850200*****
	Munnstykke, håndskraper, lengde 1000 mm	43851200*****
	Sugerørbøy alum d63	43843050*****
	Stålsvivel d63	43843100*****
	Suction pipe aluminium Ø63	43843001*****
	Munnstykke, håndskraper, lengde 500 mm	43851100*****
	Bulk munnstykke	43850100*****
	Bulk munnstykke med håndtak	43850250*****
	Munnstykke, håndskraper, lengde 1000 mm	43851250*****
	Reducer conical d76-63, Acid stainless steel	43880350
	Reducer conical d76-51, Acid stainless steel	43880300
	Hose red conical d63-51	43880250
	Hose connector d63	43880100
	Hose connector d50	43880050
	Bin Level indicator (BL) EX	40375269
	Hose joint d76, Acid stainless steel	43880150

## 600A, Configurable

Tilbehør		Artikkelnummer
	Sugehode, gulv d63/600	43840450*****

\*Ø125mm Housing in NBR, Epoxy coated cast iron and flap/sleeve in stainless steel. Temp range -20C to +120C. Height - 110 mm (260 mm in open position)

\*\*Ø150mm Housing and flap in PA. Temp range -20C to +40C. Height - 155 mm (240 mm in open position)

\*\*\*Recommended with 43630100

\*\*\*\*Can be used with valves 43630300, 43632001, 43632100, 43630201

\*\*\*\*\*Couplings included, Ø 51 mm

\*\*\*\*\*ATEX - Passer for brennbart støv (sone 20,21,22). Sørg for jording til avtrekksenhet. Må ikke brukes i områder med brennbare gasser eller til utsug av eksplosive materialer.

\*\*\*\*\*ATEX - Dette produktet passer som rengjøringsutstyr for brennbart støv med MIE (minimum ignition energy) >1 mJ. Produktet må være jordnet til avsugsenheten. Skal ikke brukes i områder med brennbar gass eller til avsug av eksplosive materialer

\*\*\*\*\*ATEX - Passer for brennbart støv (sone 20,21,22) og gass (sone 1,2) av gruppene IIA, IIB og IIC. Sørg for jording til avsugsenhet. Skal ikke brukes for avsug av eksplosive materialer

\*\*\*\*\*ATEX - Passer for brennbart støv (sone 20,21,22) og gass (sone 1,2) av gruppene IIA, IIB og IIC. Sørg for jording til avsugsenhet. Skal ikke brukes for til avsug av eksplosive materialer



## 600A, Configurable

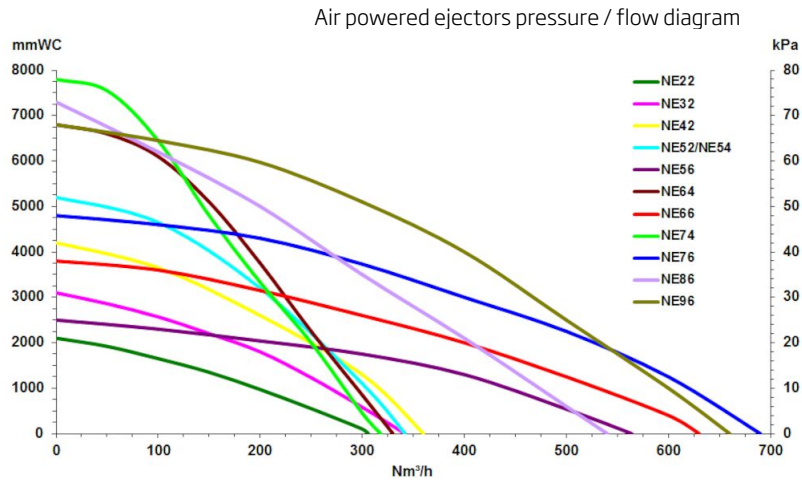

Air Powered ejectors

All performance data are based on 7 bar supply pressure

Ejector/Hose dimension	ø51mm	ø63mm	ø76mm
NE64	2	2,4	N/A
NE74	2,3	2,7	N/A
NE76	1,7	2,7	3,6
NE96	2,6	3,6	4,9

Capacity (tonne/hour) with Blasting media 2,4kg/liter and 20m hose

## 600A, Configurable

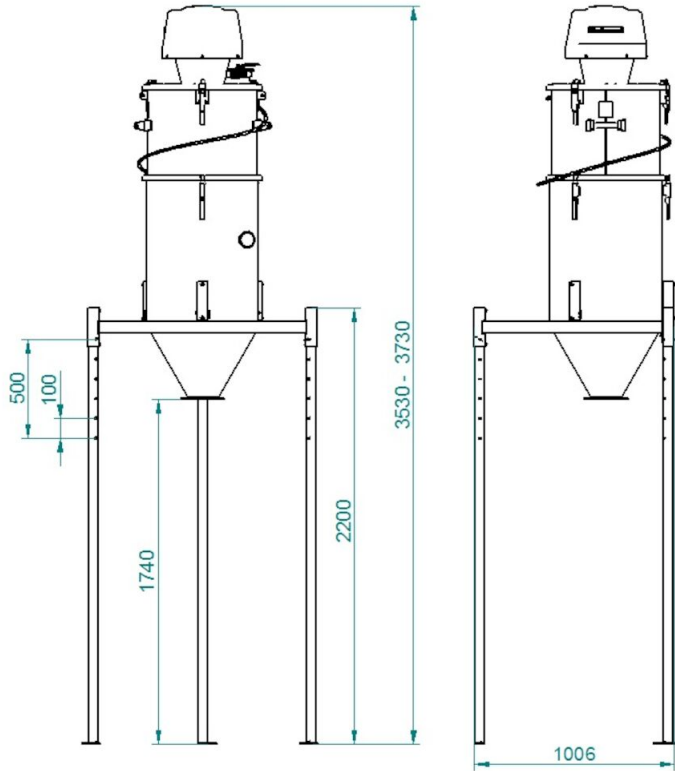

Dimensions with 2200 mm legs

## 600A, Configurable

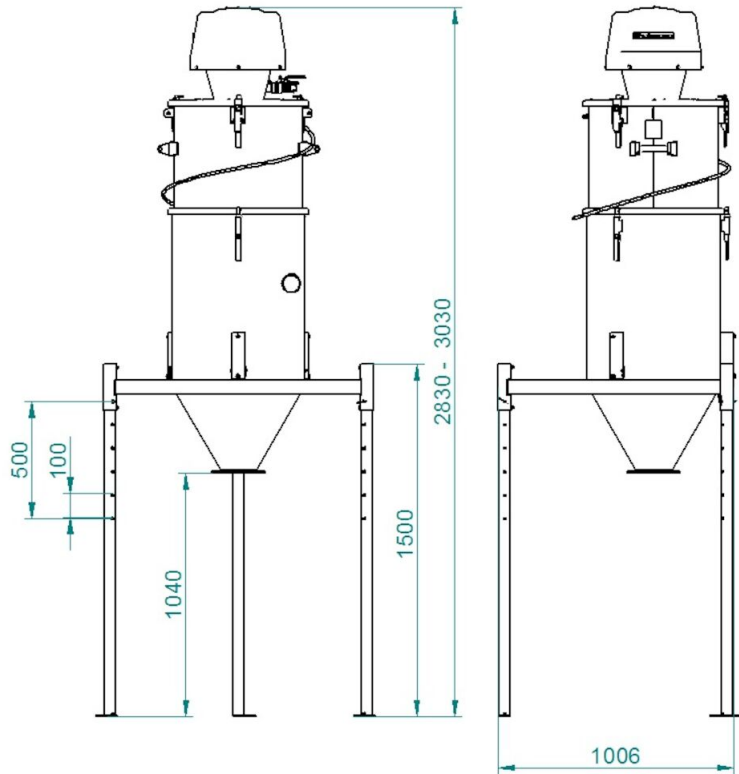

Dimensions with 1 500 mm legs