

600A, Configurable

A powerful dust collector, for suction over long horizontal and vertical distance

600A, Configurable

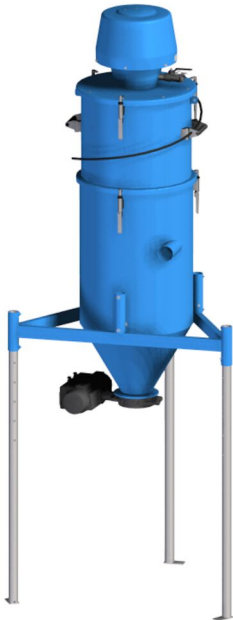

The configuration of modules will be similar to 600A which are aimed for the toughest applications, for example handling a lot of abrasive and heavy material. The robustness of the unit and the power from the reliable ejector makes the unit very suitable for many applications where many industrial vacuum cleaners can not be used. For example to collect blasting material in blasting hall, sand recovery in foundries etc.

Your unit can be configured to meet your specific demands. Different ejectors can be used depending on the demand but also the availability of compressed air. The ejector can be placed on a stationary silo with filter.

A range of different discharge valves that can be fitted to the silo for easy discharge of the collected material.

If handling larger quantities of material, Nederman recommends using a pre separator before the vacuum unit.

To configure your 600A you may only choose ejectormodule, filtermodule, silomodule and discharge valve listed in this document and with mfc (module for configuration) in title.

1. Select ejectormodule depending on required vacuum and air flow.
2. Select filtermodule depending on filter capacity.
3. Select silomodule.
4. Select discharge valve.
5. Select cleaning equipment.

Choose how to control your butterfly valve:

1. Electric controlled – You need a namur valve, solenoid valve recommended for the ejector size you choose and a control box.
2. Air controlled – You need a namur valve.

Hose for air supply to the namur valve is not supplied by Nederman.

Ensure that all requirements for the modules are met. The height of your configuration is depending on what filtermodule and legs you choose.

Robust and efficient self-cleaning filter

Very powerful and reliable ejector as vacuum producer

Suitable for heavy and/or abrasive material

Control system with many different functions is available as an accessory









品名	600A, Configurable
清灰方式	压缩空气清灰
应用	颗粒物, 沙砾, 切屑, 粉尘
除尘器类型	蜡烛过滤器
滤芯数量	70

600A, Configurable



顆粒物 沙砾 切屑 粉尘

600A, Configurable

[image]	产品名称	Compressed air requirement	Max airflow (m/h)	Noise level (dB(A))	Max vaccum (kPa)	重量 (公斤)	产品编号
	NE64, Ejectormodule with S200 lid and 2 quick couplings	4,3 Nm ³ /min @ 7 bar	330 Nm ³ /h	77	-68	18	43051000*
	Triangular frame for silo S200						43752001
	Leg straight 1500 mm						43756001**
	Leg straight 2200 mm						43756100**
	Stay-tube for legs L>2200 mm						43757001***
	NE74, Ejectormodule with S200 lid and 2 quick couplings	5,3 Nm ³ /min @ 7 bar	318 Nm ³ /h	75	-78	18	43051001*
	NE76, Ejectormodule with S200 lid and 2 quick couplings	5,4 Nm ³ /min @ 7 bar	690 Nm ³ /h	78	-48	18	43051002****
	NE96, Ejectormodule with S200 lid and 2 quick couplings	8,6 Nm ³ /min @ 7 bar	660 Nm ³ /h	78	-68	18	43051003****
	Filtermodule NCF, 5,25 m ² filterarea, 1 S200 Vyon F. MFC					55	43164101





*Recommended with filtermodule 43162101

**Each configuration needs the quantity of three legs, so to get a complete product you need to order three pieces of chosen number

***To be used with 43756100, order three pieces

****Recommended with filtermodule 43164101

600A, Configurable

附件		产品编号
	Discharge valve manual	43630001*
	Pinch valve DN65	43632001
	Manually operated butterfly discharge valve	43630400**
	Pinch valve DN80	43632100
	Pinch valve DN100	43632200
	Discharge valve with counterweight	43630200*
	Discharge valve, pneumatically operated	43630100*
	Discharge valve Linatex d100 set with reducer for flange	43630300
	Bagholder for 43630200 or 43631001	43640001
	Bagholder for 43630100, for pneumatic discharge valve	43640003***
	Plastic bag S50 – 25pcs 630x800	43650104
	Bagholder big bag with pneumatically operated discharge valve	43640201
	Bagholder for big bag, MFC	43640217****
	Control S for NE 22-76	43220026
	Control S for NE86-96	43222008
	Control S for NE 22-76	43220001
	Electrical Control system for ejector NE 86	43222001
	Mountingplate for controlbox, S200	43690001
	Control system for ejectors	43220034
	Level control for silo continuous feed out	43251001
	软管 PU12 51 L=10m	43832600
	软管 PU12 51 L=5m	43832500

600A, Configurable

附件		产品编号
	软管 PU12 51 L=20m	43832300
	软管 PU12 51 L=7,5m w. 接头	43832102*****
	Hose PU12 51 L=10m w. couplers	43832200*****
	软管 PU12 63 L=5m	43833200
	软管 PU12 63 L=10m	43833001
	软管 PU12 63 L=20m	43833100
	软管 PU12 76 L=10m	43834200
	软管 PU12 76 L=20m	43834300
	Floor cleaning equipment width 500 mm with small nylon wheels 51 and rubber lips	42932100*****
	Floor cleaning equipment width 400 mm without wheels for dry suction 51, with brushes	42932800*****
	Floor cleaning equipment width 400 mm with large rubber wheels 51 and rubber lips	42932300*****
	地面吸嘴, 宽500 mm 带尼龙小轮, 51	43840150*****
	地面吸嘴, 宽400 mm 带橡胶大轮, 51	43840250*****
	地面吸嘴, 宽400 mm 不带轮, 干式抽吸, 51	43840550*****
	手持吸嘴, 硬刷90mm, 51	43860001*****
	锯齿形吸嘴 宽130 mm, 51	43861001*****
	锥形吸嘴 长250 mm, 51	43862001*****
	弯头, 51 mm	43842150*****
	清洁管道, 长1100 mm, 51 mm	43842001*****
	可拆卸吸嘴, 用于地面, 带手柄, 长1200 mm, 51 mm	43850150*****
	可拆卸吸嘴, 长910 mm, 51	43850001*****
	开槽吸嘴, 长1000 mm 51	43851150*****

600A, Configurable

附件		产品编号
	开槽吸嘴, 长500 mm 51	43851050*****
	钢碎屑吸嘴, 50 mm, 消音入风口	40150030*****
	地面吸头, 宽500mm, 63	43840400*****
	可拆卸吸嘴, 长910 mm, 镀锌, 63	43850050*****
	可拆卸吸嘴, 长910 mm, 用于旋转座 (43843100), 63	43850051*****
	可拆卸吸嘴, 用于地面, 长1200 mm, 63 mm	43850200*****
	开槽手持吸嘴, 长1000 mm, 63	43851200*****
	抽排铝管弯头 d63	43843050*****
	钢旋转街头 d63	43843100*****
	抽排管道 铝 63	43843001*****
	开槽手持吸嘴, 长500 mm, 63	43851100*****
	可拆卸吸嘴, 长910 mm, d76, 镀锌	43850100*****
	可拆卸吸嘴, 带手柄, 76	43850250*****
	开槽手持吸嘴, 长1000 mm, 76	43851250*****
	变径d76-63, 耐酸不锈钢	43880350
	变径d76-51, 耐酸不锈钢	43880300
	变径d63-51	43880250
	软管接头 d63	43880100
	软管接头 d50	43880050
	Bin Level indicator (BLI) EX	40375269
	软管接头 d76, 耐酸不锈钢	43880150
	地板吸头 d63/600	43840450*****

600A, Configurable

*150mm Housing and flap in PA. Temp range -20C to +40C. Height - 155 mm (240 mm in open position)

**125mm Housing in NBR, Epoxy coated cast iron and flap/sleeve i stainless steel. Temp range -20C to +120C. Height - 110 mm (260 mm in open position)

***Recommended with 43630100

****Can be used with valves 43630300, 43632001, 43632100, 43630201

*****Couplings included, 51 mm

*****ATEX: 适用于可燃粉尘 (20区,21区,22区)。确保抽排设备接地。不能用于可燃气体环境和易爆物质的抽排。

*****ATEX - This product is suitable to be used as cleaning equipment for combustible dusts with MIE (minimum ignition energy) >1 mJ. Product is to be properly earthed to the extraction unit. Not for usage in combustible gas atmospheres or extraction of explosive materials.

*****ATEX - This product is suitable to be used as cleaning equipment for combustible dusts with MIE (minimum ignition energy) >1 mJ. Product is to be properly earthed to the extraction unit. Not for usage in combustible gas atmospheres or extraction of explosive materials.

*****ATEX - Suitable for combustible dust (zone 20,21,22) and gas (zone 1,2) of group IIA, IIB and IIC. Ensure earthing to extraction unit. Not to be used for extraction of explosive materials

*****ATEX - Suitable for combustible dust (zone 20,21,22) and gas (zone 1,2) of group IIA, IIB and IIC. Ensure earthing to extraction unit. Not to be used for extraction of explosive materials.

*****ATEX: 适合易燃粉尘 (20、21、22区) 和气体 (1、2区) 类别 IIA、IIB 和 IIC。确保抽排装置接地。不适合抽排爆炸性物料

600A, Configurable

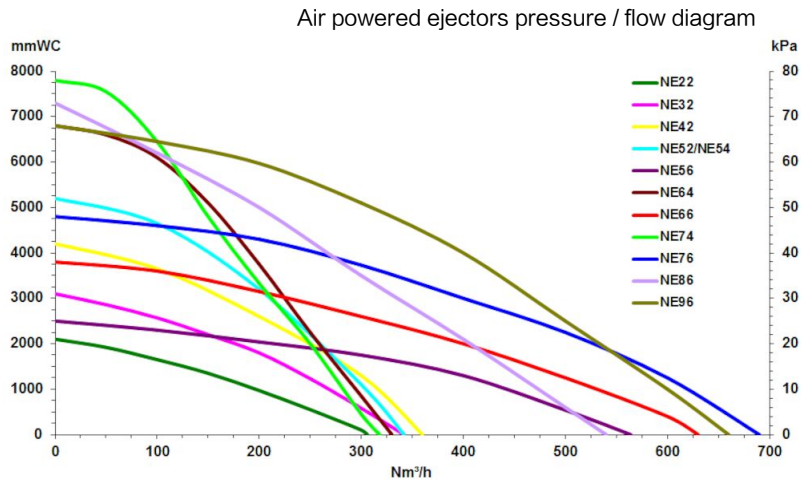

Air Powered ejectors

All performance data are based on 7 bar supply pressure

Ejector/Hose dimension	ø51mm	ø63mm	ø76mm
NE64	2	2,4	N/A
NE74	2,3	2,7	N/A
NE76	1,7	2,7	3,6
NE96	2,6	3,6	4,9

Capacity (tonne/hour) with Blasting media 2,4kg/liter and 20m hose

600A, Configurable

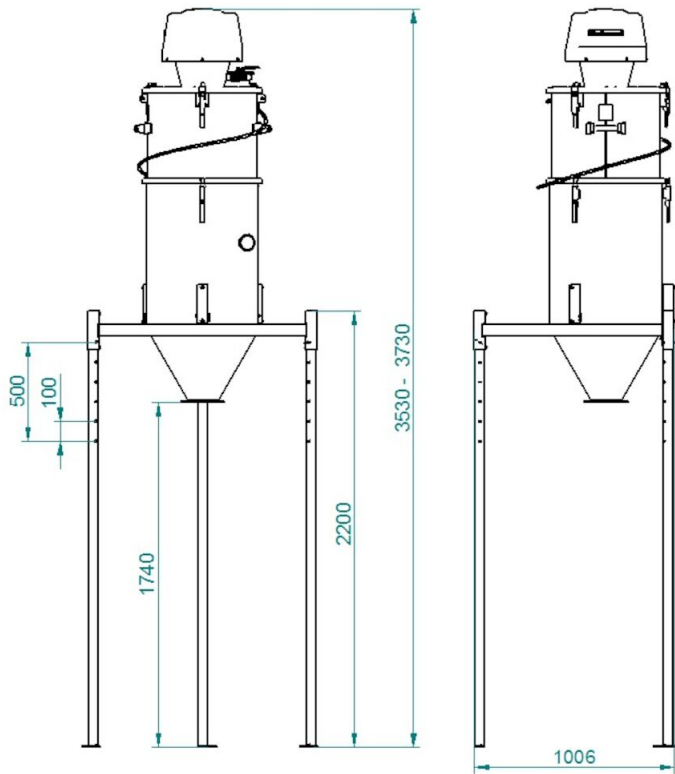

Dimensions with 2200 mm legs

600A, Configurable

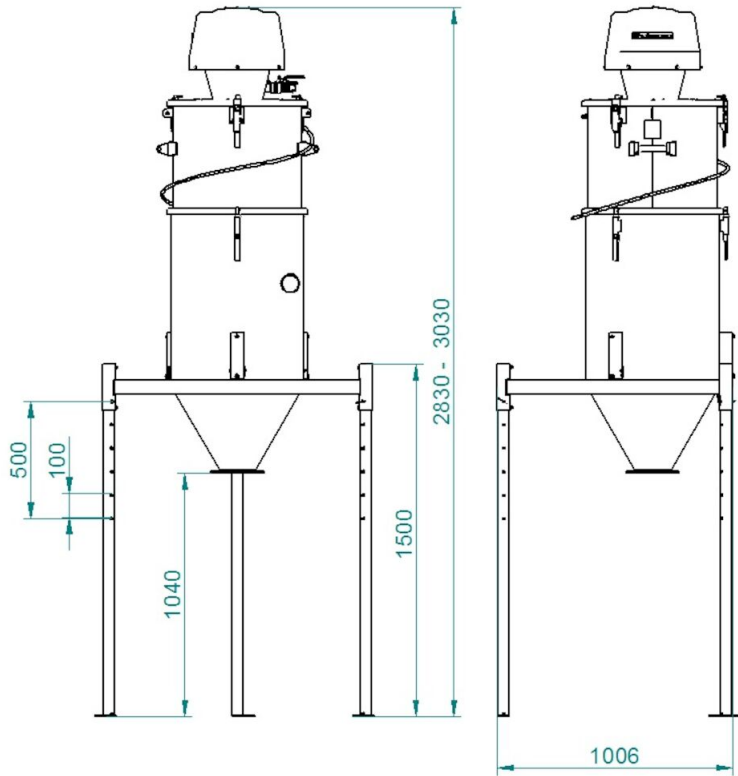

Dimensions with 1 500 mm legs