

## 471A configurable

A powerful dust collector, excellent high vacuum for suction over long horizontal and vertical distance

---

## 471A configurable

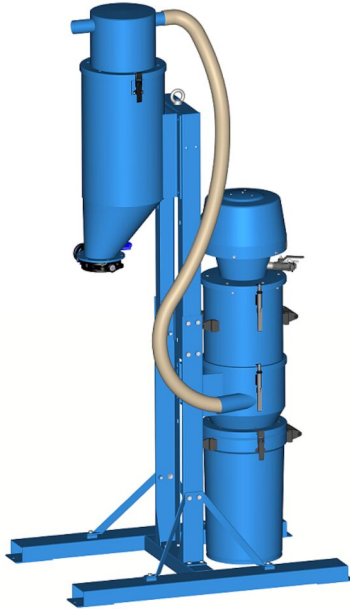

Nederman Pre-separation and Vacuum Transportation Systems pre-separate and discharge dust and granulated material during vacuuming and vacuum transport.

A system can handle dry material like cement, fertilizers, grit, sand, as well as wet material. Collected material can be discharged into tanks, containers, big-bags, on to conveyor belts, escalators etc.

The configuration of modules will be similar to 471A which are aimed for the toughest applications, for example handling a lot of abrasive and heavy material. The robustness of the unit and the power from the reliable ejector makes the unit very suitable for many applications where many industrial vacuum cleaners can not be used. For example to collect blasting material in blasting hall, sand recovery in foundries etc.

Your unit can be configured to meet your specific demands. Different ejectors can be used depending on the demand but also the availability of compressed air. The ejector can be placed on a stationary silo with filter.

Nederman has a range of different discharge valves that can be fitted to the silo for easy discharge of the collected material. If handling larger quantities of material and in order to make the material handling more effective Nederman recommends using a pre separator before the vacuum unit. The 471A is a complete unit including a pre separator.

To configure your 471A you may only choose modules listed in this document and with mfc (module for configuration) in title.

1. Select ejectormodule depending on required vacuum and air flow.
2. Select filtermodule depending on filter capacity.
3. Select silomodule depending on disposal option.
4. Select disposal option, container or discharge valve with plastic bag.
5. Select coarse grain separator.
6. Select silo.
7. Select discharge valve.
8. Select frame.
9. Select hose for connection between vacuum cleaner and separator.
10. Select cleaning equipment.

Choose how to control your butterfly valve:

1. Electric controlled
  - You need a namur valve, solenoid valve recommended for the ejector size you choose and a suitable control box.
2. Air controlled
  - You need a namur valve.

Hose for air supply to the namur valve is not supplied by Nederman. Ensure you meet all requirements for your modules.

- 
- Robust and efficient self-cleaning filter

## 471A configurable

- Very powerful and reliable ejector as vacuum producer
- Suitable for heavy and/or abrasive material
- Control system with many different functions is available as an accessory

Product name	471A configurable
Filter cleaning method	[CompressedAir]
Filter Area (ft <sup>2</sup> )	1,6
Filter type	[NCF]
Number of filter elements	36
Max airflow (m <sup>3</sup> /h)	342 Nm <sup>3</sup> /h
Inlet	76 mm



## 471A configurable

[image]	Description	Compressed air requirement	Noise level (dB(A))	Max vakuum (in. wg)	Weight (lbs)	[model]
	NE52, Ejectormodule with S50 lid and 2 quick coupling	7 bar and 3,0 Nm <sup>3</sup> /min	75,5	-52	13	43051004
	NE64, Ejectormodule with S50 lid and 2 quick coupling	7 bar and 4,3 Nm <sup>3</sup> /min	77	-68	13	43051005
	NE74, Ejectormodule with S50 lid and 2 quick coupling	7 bar and 5,3 Nm <sup>3</sup> /min	75	-78	13	43051006
	Filtermodule, NCF1.6-I S50 Vyon F				22	43160101
	Silo S50 with plastic fasteners, inlet ø76, for container				12	43420026
	Silo S50 with plastic fasteners, inlet ø76, for discharge valve				12	43420027
	Bagholder for 43630200 or 43631001				3	43640001
	Bagholder for 43630100, for pneumatic discharge valve				3	43640003*
	Adjustable frame with bottom for S200 system and stand for S50 system				55	43751039**
	Adjustable frame with bottom for S50 system and stand for S50 system				50	43751040***
	Silo S50 for wall, without inlet				24	43413026
	Container S50 with excentric fastners and antistatic handles					43332001
	Container 67l					43334001
	Coarse grain separator S50 d63/76 for plastic fasteners				15	43550002****
	Coarse grain separator S50 d51/76 for plastic fasteners				15	43550005*****

\*Recommended with 43630100

\*\*Fits blastpots up to 680mm width. Max height 2,3m.





\*\*\*Fits blastpots up to 560mm width. Max height 2,3m.

## 471A configurable















\*\*\*\*Suitable for suction hose PU12 Ø51mm with coupler 40377028

\*\*\*\*Flap valve 43885001 can be used on the inlet







## 471A configurable

	[accessory]	[partno]
	Discharge valve manual	43630001*
	Manually operated butterfly discharge valve	43630400**
	Pinch valve DN65	43632001
	Pinch valve DN80	43632100
	Pinch valve DN100	43632200
	Discharge valve with counterweight	43630200*
	Discharge valve, pneumatically operated	43630100*
	Discharge valve Linatex d100 set with reducer for flange	43630300
	Control System for Ejectors	43220034
	Mounting plate Controlbox S50	43690009
	Level control for silo continuous feed out	43251001
	Bin Level indicator (BLI) EX	40375269
	Plastic bag S50 - 25pcs 630x800	43650104
	Joint sleeve 65	40377028
	Joint sleeve for pipes 76mm, hoseclamp included	40130990
	Joint sleeve d75-89/d53-63mm	43884464
	Joint sleeve d65-75	43884463
	Hose PU12 Ø 51 L=10m	43832600
	Hose PU12 Ø 51 L=5m	43832500
	Hose PU12 Ø 51 L=20m	43832300
	Hose PU12 Ø 51 L=7,5m w. couplings	43832102***
	Hose PU12 Ø 51 L=10m w. couplers	43832200***

## 471A configurable

	[accessory]	[partno]
	Hose PU12 Ø 63 L=5m	43833200
	Hose PU12 Ø 63 L=10m	43833001
	Hose PU12 Ø 63 L=20m	43833100
	Floor cleaning equipment width 500 mm with small nylon wheels Ø51	42932100****
	Floor cleaning equipment width 400 mm without wheels for dry suction Ø51	42932800****
	Floor cleaning equipment width 400 mm with large rubber wheels Ø51	42932300****
	Floor nozzle, width 500 mm with small nylon wheels, Ø51	43840150*****
	Floor nozzle, width 400 mm with large rubber wheels, Ø51	43840250*****
	Floor nozzle width 400 mm without wheels for dry suction, Ø51	43840550*****
	Hand nozzle, hard brush Ø90mm, Ø51	43860001****
	Toothed nozzle width 130 mm, Ø51	43861001*****
	Cone nozzle Length 250 mm, Ø51	43862001*****
	Elbow pipe, Ø51 mm	43842150*****
	Cleaning pipe, length 1100 mm, Ø51 mm	43842001*****
	Bulk nozzle for floor with handle length 1200 mm, Ø51 mm	43850150*****
	Bulk nozzle Length 910 mm, Ø51	43850001****
	Scraper nozzle, length: 1000 mm Ø51	43851150*****
	Scraper nozzle, length: 500 mm Ø51	43851050*****
	Steel swarf nozzle, Ø50 mm, Silenced inlet	40150030*****
	Floor suction head width 500mm, Ø63	43840400*****
	Bulk nozzle length 910 mm, galvanized, Ø63	43850050*****
	Bulk nozzle length 910 mm for swivel (43843100), Ø63	43850051*****

## 471A configurable

	[accessory]	[partno]
	Bulk nozzle for floor, length 1200 mm, Ø63 mm	43850200*****
	Scraper hand nozzle, length 1000 mm, Ø63	43851200*****
	Suction pipe aluminium Ø63	43843001*****
	Suct pipe bend alum d63	43843050*****
	Swivel steel d63	43843100*****
	Control S for NE 22-76	43220001
	Control S for NE 22-76	43220026
	Control S for NE86-96	43222008

\*Ø150mm Housing and flap in PA. Temp range -20C to +40C. Height - 155 mm (240 mm in open position)

\*\*Ø125mm Housing in NBR, Epoxy coated cast iron and flap/sleeve i stainless steel. Temp range -20C to +120C. Height - 110 mm (260 mm in open position)

\*\*\*Couplings included, Ø 51 mm

\*\*\*\*ATEX - Suitable for combustible dust with MIE (minimum ignition energy) < 1mJ. Ensure earthing to extraction unit. Not to be used in combustible gas atmospheres or extraction of explosive materials

\*\*\*\*\*ATEX - This product is suitable to be used as cleaning equipment for combustible dusts with MIE (minimum ignition energy) > 1 mJ. Product is to be properly earthed to the extraction unit. Not for usage in combustible gas atmospheres or extraction of explosive materials.

\*\*\*\*\*ATEX - Suitable for combustible dust (zone 20,21,22) and gas (zone 1,2) of group IIA , IIB and IIC. Ensure earthing to extraction unit. Not to be used for extraction of explosive materials



## 471A configurable

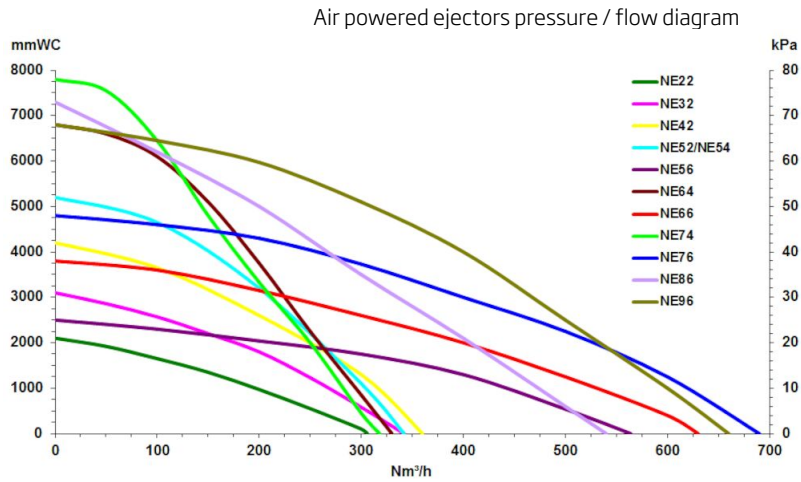

Air Powered ejectors

All performance data are based on 7 bar supply pressure

Ejector/Hose dimension	ø51mm	ø63mm	ø76mm
NE52	2	N/A	N/A
NE64	2	2,4	N/A
NE74	2,3	2,7	N/A
NE76	1,7	2,7	3,6
NE96	2,6	3,6	4,9

Capacity (tonne/hour) with Blasting media 2,4kg/liter and 20m hose

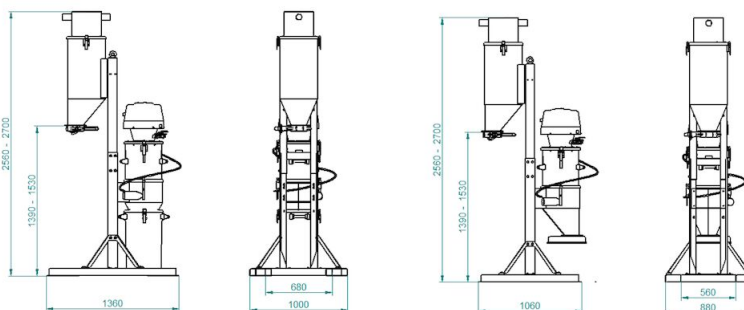

The height of your configuration is depending on which modules you choose