

## 710A, Configurable.

A powerful dust collector, excellent high vacuum for suction over long horizontal and vertical distance

---

## 710A, Configurable.

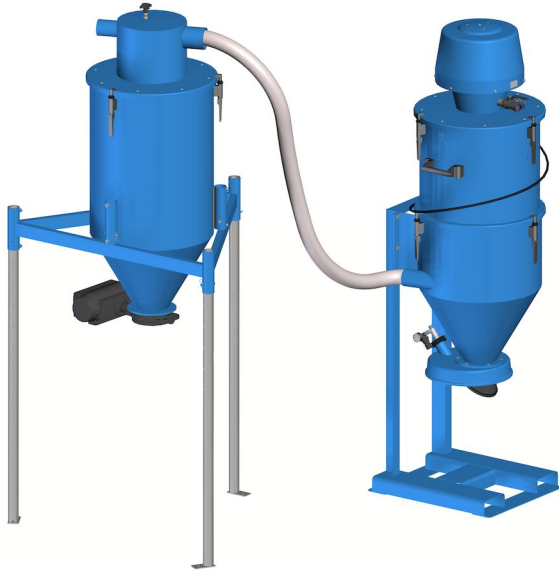

Nederman Pre-separation and Vacuum Transportation Systems pre-separate and discharge dust and granulated material during vacuuming and vacuum transport.

A system can handle dry material like cement, fertilizers, grit, sand, as well as wet material. Collected material can be discharged into tanks, containers, big-bags, on to conveyor belts, escalators etc.

The configuration of modules will be similar to 710A which are aimed for the toughest applications, for example handling a lot of abrasive and heavy material. The robustness of the unit and the power from the reliable ejector makes the unit very suitable for many applications where many industrial vacuum cleaners can not be used. For example to collect blasting material in blasting hall, sand recovery in foundries etc.

Your unit can be configured to meet your specific demands.

Different ejectors can be used depending on the demand but also the availability of compressed air. The ejector can be placed on a stationary silo with filter.

Nederman has a range of different discharge valves that can be fitted to the silo for easy discharge of the collected material.

If handling larger quantities of material and in order to make the material handling more effective Nederman recommends using a pre separator before the vacuum unit. The 710A is a complete unit including a pre separator.

To configure your 710A you may only choose modules listed in this document and with mfc (module for configuration) in title.

Filterside:

1. Select ejectormodule depending on required vacuum and air flow.
2. Select filtermodule depending on filter capacity.
3. Select silomodule.
4. Select disposal option, bagholder and discharge valve.
5. Select frame.

Separatorside:

1. Select coarse grain separator.
2. Select silomodule.
3. Select discharge valve.
4. Select frame.
5. Select hose for connection between vacuum cleaner and separator.
6. Select joint sleeve depending on coarse grain separator and hose.
7. Select cleaning equipment.

Choose how to control your butterfly valve:

1. Electric controlled
  - You need a namur valve, solenoid valve recommended for the ejector size you choose and a suitable control box.
2. Air controlled
  - You need a namur valve.

Hose for air supply to the namur valve is not supplied by Nederman.

## 710A, Configurable.

Ensure you meet all requirements for your modules

- Robust and efficient self-cleaning filter
- Very powerful and reliable ejector as vacuum producer
- Suitable for heavy and/or abrasive material
- Control system with many different functions is available as an accessory

|                       |                                    |
|-----------------------|------------------------------------|
| Produktnavn           | 710A, Configurable.                |
| Bruksområde           | [granulate], [grit], [swarf], Støv |
| Filtertype            | Kuvertfilter                       |
| Antal filterelementer | 70                                 |

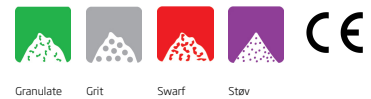

## 710A, Configurable.

| Bilde   | Navn på datablad   | Compressed air requirement       | Max airflow (m <sup>3</sup> /h) | Noise level (dB(A)) | Max vaccum (kPa) | Vekt (kg) | Model        |
|---|--|----------------------------------|---------------------------------|---------------------|------------------|-----------|--------------|
|    | NE64, Ejectormodule with S200 lid and 2 quick couplings              | 4,3 Nm <sup>3</sup> /min @ 7 bar | 330 Nm <sup>3</sup> /h          | 77                  | -68              | 18        | 43051000*    |
|    | Frame for 43461001, H=1325   |                                  |                                 |                     |                  |           | 43750001     |
|    | Silo S200 for leg mounting without inlet                             |                                  |                                 |                     |                  |           | 43441001     |
|    | Coarse grain separator S200 d76/76 for plastic fasteners             |                                  |                                 |                     |                  |           | 43561001     |
|    | Coarse grain separator d102/76 adjustable for plastic fasteners      |                                  |                                 |                     |                  |           | 43661008     |
|   | NE74, Ejectormodule with S200 lid and 2 quick couplings              | 5,3 Nm <sup>3</sup> /min @ 7 bar | 318 Nm <sup>3</sup> /h          | 75                  | -78              | 18        | 43051001*    |
|  | NE76, Ejectormodule with S200 lid and 2 quick couplings              | 5,4 Nm <sup>3</sup> /min @ 7 bar | 690 Nm <sup>3</sup> /h          | 78                  | -48              | 18        | 43051002**   |
|  | NE96, Ejectormodule with S200 lid and 2 quick couplings              | 8,6 Nm <sup>3</sup> /min @ 7 bar | 660 Nm <sup>3</sup> /h          | 78                  | -68              | 18        | 43051003**   |
|  | Filtermodule NCF, 5,25 m <sup>2</sup> filterarea, 1 S200 Vyon F. MFC |                                  |                                 |                     |                  | 55        | 43164101     |
|  | Silo S200 for wall mounting, d76 suction inlet, with flange          |                                  |                                 |                     |                  |           | 43461007     |
|  | Triangular frame for silo S200                                       |                                  |                                 |                     |                  |           | 43752001     |
|  | Leg straight 1500 mm   |                                  |                                 |                     |                  |           | 43756001***  |
|  | Leg straight 2200 mm   |                                  |                                 |                     |                  |           | 43756100***  |
|  | Stay-tube for legs L > 2200 mm                                       |                                  |                                 |                     |                  |           | 43757001**** |
|  |  |                                  |                                 |                     | 61               |           | 43834100     |

\*Recommended with filtermodule 43162101























\*\*Recommended with filtermodule 43164101

\*\*\*Each configuration needs the quantity of three legs, so to get a complete product you need to order three pieces of chosen number

# 710A, Configurable.

*\*\*\*\*To be used with 43756100, order three pieces*























## 710A, Configurable.

| Tilbehør  |   | Artikelnummer |
|---|---|---------------|
|    | Pneumatically operated butterfly discharge valve              | 43630500*     |
|    | Discharge valve manual  | 43630001**    |
|    | Pinch valve DN65  | 43632001      |
|    | Manually operated butterfly discharge valve                   | 43630400*     |
|    | Pinch valve DN80  | 43632100      |
|    | Pinch valve DN100   | 43632200      |
|    | Discharge valve with counterweight                            | 43630200**    |
|   | Discharge valve, pneumatically operated                       | 43630100**    |
|  | Discharge valve Linatex d100 set with reducer for flange      | 43630300      |
|  | Bagholder for 43630200 or 43631001                            | 43640001      |
|  | Bagholder for 43630100, for pneumatic discharge valve         | 43640003***   |
|  | Bagholder big bag with pneumatically operated discharge valve | 43640201      |
|  | Bagholder for big bag, MFC                                    | 43640217****  |
|  | Control S for NE 22-76  | 43220026      |
|  | Control S for NE86-96   | 43220008      |
|  | Control S for NE 22-76  | 43220001      |
|  | Electrical Control system for ejector NE 86                   | 43222001      |
|  | Mountingplate for controlbox, S200                            | 43690001      |
|  | Control system for ejectors                                   | 43220034      |
|  | Level control for silo continuous feed out                    | 43251001      |
|  | Slange PU12 Ø 51 L=10 m                                       | 43832600      |
|  | Slange PU12 Ø 51 L=5m   | 43832500      |

## 710A, Configurable.



|   | Tilbehør   | Artikkelnummer |
|---|--|----------------|
|    | Slange PU12 Ø 51 L=20 m  | 43832300       |
|    | Slange PU12 Ø 51 L=7,5m med koblinger  | 43832102*****  |
|    | Slange PU12 Ø 51 L=10 m m/koblinger  | 43832200*****  |
|    | Slange PU12 Ø 63 L=5m  | 43833200       |
|    | Slange PU12 Ø 63 L=10 m  | 43833001       |
|    | Slange PU12 Ø 63 L=20 m  | 43833100       |
|    | Slange PU12 Ø 76 L=10 m  | 43834200       |
|   | Slange PU12 Ø 76 L=20 m  | 43834300       |
|  | Sugeutstyr komplett for gulv. Munnstykke med d38 hjul og gummilepper. Bredde 500mm. D51 tilkobling | 42932100*****  |
|  | Sugeutstyr komplett for gulv. Uten hjul.Med børster. Bredde 400mm. D51 tilkobling                  | 42932800*****  |
|  | Sugeutstyr komplett for gulv. Munnstykke med d65 hjul og gummilepper. Bredde 400mm. D51 tilkobling | 42932300*****  |
|  | Gulvmunnstykke,bredde 500 mm med små nylonhjul   | 43840150*****  |
|  | Gulvmunnstykke,bredde 400 mm med store gummihjul   | 43840250*****  |
|  | Gulvmunnstykke bredde 400 mm uten hjul for tørrsuging  | 43840550*****  |
|  | Håndmunnstykke,hard børste Ø90 mm  | 43860001*****  |
|   | Tannet munnstykke bredde 130 mm  | 43861001*****  |
|  | Konisk munnstykke Lengde 250 mm  | 43862001*****  |
|  | Albuerør,Ø51 mm  | 43842150*****  |
|  | Rengjøringsrør,lengde 1100 mm,Ø51 mm   | 43842001*****  |
|  | Bulk munnstykke for gulv lengde 1200 mm  | 43850150*****  |
|  | Bulk munnstykke Lengde 910 mm  | 43850001*****  |
|  | Skrapemunnstykke,lengde: 1000 mm   | 43851150*****  |

## 710A, Configurable.

| Tilbehør  |  | Artikkelnummer |
|---|--|----------------|
|    | Skrapemunnstykke, lengde: 500 mm             | 43851050*****  |
|    | Stålsponmunnstykke, Ø50 mm, dempet innløp    | 40150030*****  |
|    | Floor suction head width 500mm, Ø63          | 43840400*****  |
|    | Bulk munnstykke lengde 910 mm                | 43850050*****  |
|    | Bulk munnstykke lengde 910 mm for svivel     | 43850051*****  |
|    | Bulk munnstykke for gulv, lengde 1200 mm     | 43850200*****  |
|    | Munnstykke, håndskraper, lengde 1000 mm      | 43851200*****  |
|   | Sugerørbøy alum d63                          | 43843050*****  |
|  | Stålsvivel d63                               | 43843100*****  |
|  | Suction pipe aluminium Ø63                   | 43843001*****  |
|  | Munnstykke, håndskraper, lengde 500 mm       | 43851100*****  |
|  | Bulk munnstykke                              | 43850100*****  |
|  | Bulk munnstykke med håndtak                  | 43850250*****  |
|  | Munnstykke, håndskraper, lengde 1000 mm      | 43851250*****  |
|  | Reducer conical d76-63, Acid stainless steel | 43880350       |
|  | Reducer conical d76-51, Acid stainless steel | 43880300       |
|  | Hose red conical d63-51                      | 43880250       |
|  | Hose connector d63                           | 43880100       |
|  | Hose connector d50                           | 43880050       |
|  | Bin Level Indicator (BLI) EX                 | 40375269       |
|  | Joint sleeve d75-89/d53-63mm                 | 43884464       |
|  | Joint sleeve d65-75                          | 43884463       |



## 710A, Configurable.

|   | Tilbehør                             | Artikkelnummer |
|---|--------------------------------------|----------------|
|   | Joint sleeve d98-114/d70-88          | 43884462       |
|  | Hose joint d76, Acid stainless steel | 43880150       |
|  | Sugehode, gulv d63/600               | 43840450*****  |

\*Ø125mm Housing in NBR, Epoxy coated cast iron and flap/sleeve i stainless steel. Temp range -20C to +120C. Height - 110 mm (260 mm in open position)

\*\*Ø150mm Housing and flap in PA. Temp range -20C to +40C. Height - 155 mm (240 mm in open position)

\*\*\*Recommended with 43630100

\*\*\*\*Can be used with valves 43630300, 43632001, 43632100, 43630201

\*\*\*\*\*Couplings included, Ø 51 mm

\*\*\*\*\*ATEX - Passer for brennbart støv (sone 20,21,22). Sørg for jording til avtrekksenheter. Må ikke brukes i områder med brennbare gasser eller til utsug av eksplosive materialer.

\*\*\*\*\*ATEX - Dette produktet passer som rengjøringsutstyr for brennbart støv med MIE (minimum ignition energy) >1 mJ. Produktet må være jordet til avsugsenheter. Skal ikke brukes i områder med brennbar gass eller til avsug av eksplosive materialer

\*\*\*\*\*ATEX - Passer for brennbart støv (sone 20,21,22) og gass (sone 1,2) av gruppene IIA, IIB og IIC. Sørg for jording til avsugsenheter. Skal ikke brukes for avsug av eksplosive materialer

\*\*\*\*\*ATEX - Passer for brennbart støv (sone 20,21,22) og gass (sone 1,2) av gruppene IIA, IIB og IIC. Sørg for jording til avsugsenheter. Skal ikke brukes for til avsug av eksplosive materialer

## 710A, Configurable.

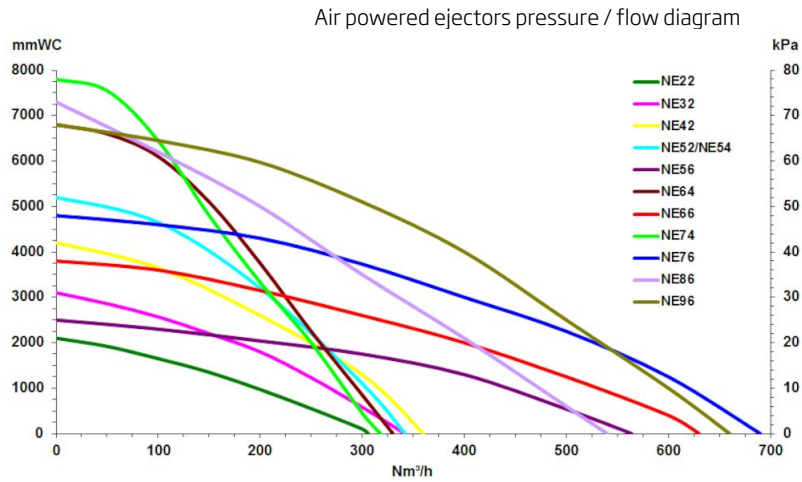

Air Powered ejectors

All performance data are based on 7 bar supply pressure

| Ejector/Hose dimension | ø51mm | ø63mm | ø76mm |
|------------------------|-------|-------|-------|
| NE64                   | 2     | 2,4   | N/A   |
| NE74                   | 2,3   | 2,7   | N/A   |
| NE76                   | 1,7   | 2,7   | 3,6   |
| NE96                   | 2,6   | 3,6   | 4,9   |

Capacity (tonne/hour) with Blasting media 2,4kg/liter and 20m hose

# 710A, Configurable.

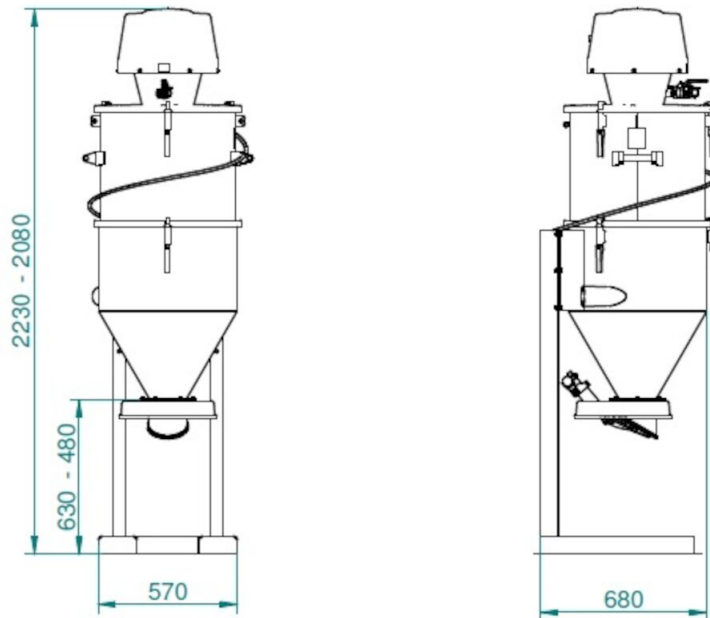

Dimensions - Filter part

# 710A, Configurable.

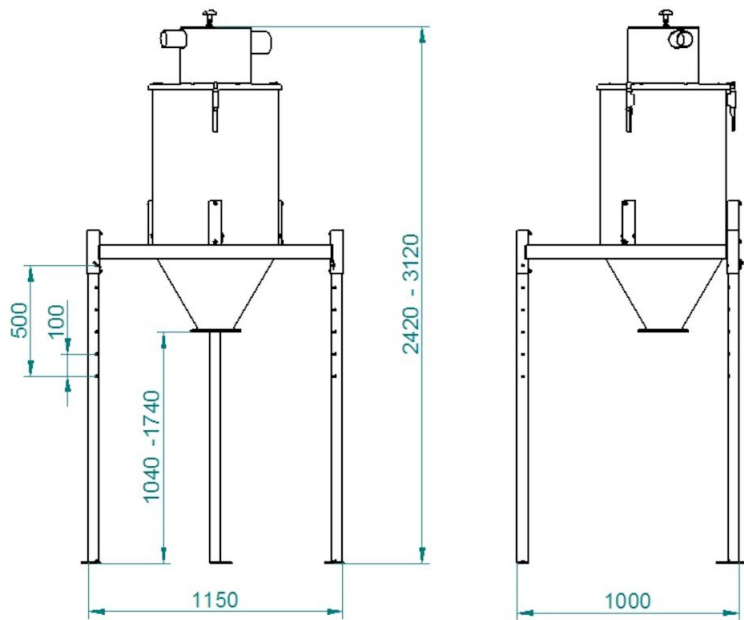

Dimensions pre-separation part