

710A, Configurable.

A powerful dust collector, excellent high vacuum for suction over long horizontal and vertical distance

710A, Configurable.

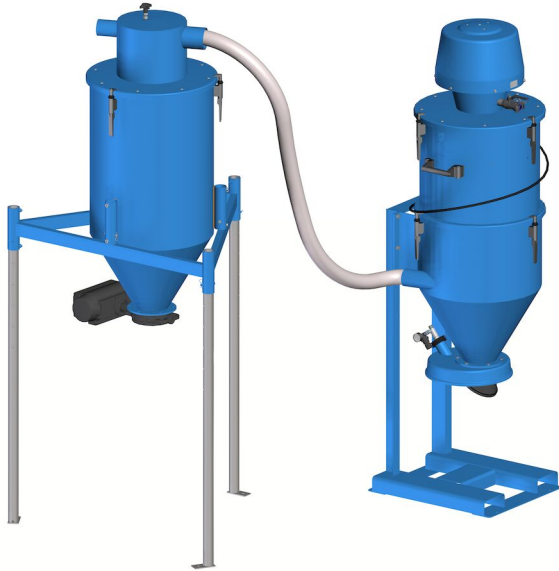

Nederman Pre-separation and Vacuum Transportation Systems pre-separate and discharge dust and granulated material during vacuuming and vacuum transport.

A system can handle dry material like cement, fertilizers, grit, sand, as well as wet material. Collected material can be discharged into tanks, containers, big-bags, on to conveyor belts, escalators etc.

The configuration of modules will be similar to 710A which are aimed for the toughest applications, for example handling a lot of abrasive and heavy material. The robustness of the unit and the power from the reliable ejector makes the unit very suitable for many applications where many industrial vacuum cleaners can not be used. For example to collect blasting material in blasting hall, sand recovery in foundries etc.

Your unit can be configured to meet your specific demands.

Different ejectors can be used depending on the demand but also the availability of compressed air. The ejector can be placed on a stationary silo with filter.

Nederman has a range of different discharge valves that can be fitted to the silo for easy discharge of the collected material.

If handling larger quantities of material and in order to make the material handling more effective Nederman recommends using a pre separator before the vacuum unit. The 710A is a complete unit including a pre separator.

To configure your 710A you may only choose modules listed in this document and with mfc (module for configuration) in title.

Filterside:

1. Select ejector module depending on required vacuum and air flow.
2. Select filter module depending on filter capacity.
3. Select silo module.
4. Select disposal option, bagholder and discharge valve.
5. Select frame.

Separator side:

1. Select coarse grain separator.
2. Select silo module.
3. Select discharge valve.
4. Select frame.
5. Select hose for connection between vacuum cleaner and separator.
6. Select joint sleeve depending on coarse grain separator and hose.
7. Select cleaning equipment.

Choose how to control your butterfly valve:

1. Electric controlled
 - You need a namur valve, solenoid valve recommended for the ejector size you choose and a suitable control box.
2. Air controlled
 - You need a namur valve.

Hose for air supply to the namur valve is not supplied by Nederman.

710A, Configurable.

Ensure you meet all requirements for your modules

- Robust and efficient self-cleaning filter
- Very powerful and reliable ejector as vacuum producer
- Suitable for heavy and/or abrasive material
- Control system with many different functions is available as an accessory

Produkt namn	710A, Configurable.
Applikation	Granulat, Grus, Spån, Stoft
Typ av filter	Stavfilter
Antal filter	70

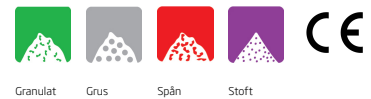

710A, Configurable.

Bild	Beskrivning	Tryckluftsbbehov	Max luftflöde (m ³ /h)	Ljudnivå (dB(A))	Max vaccum (kPa)	Vikt (kg)	Model
	NE64, ejektormodul med S200 och 2 snabbkopplingar	4,3 Nm ³ /min @ 7 bar	330 Nm ³ /h	77	-68	18	43051000*
	Ram för 43461001, H=1325						43750001
	Silo S200 för montering på ben, utan inlopp						43441001
	Grovkornsseparator S200 d76/76 för plastfästen						43561001
	Coarse grain separator d102/76 adjustable for plastic fasteners						43661008
	NE74, ejektormodul med S200 och 2 snabbkopplingar	5,3 Nm ³ /min @ 7 bar	318 Nm ³ /h	75	-78	18	43051001*
	NE76, ejektormodul med S200 och 2 snabbkopplingar	5,4 Nm ³ /min @ 7 bar	690 Nm ³ /h	78	-48	18	43051002**
	NE96, ejektormodul med S200 och 2 snabbkopplingar	8,6 Nm ³ /min @ 7 bar	660 Nm ³ /h	78	-68	18	43051003**
	Filtermodul NCF, 5,25 m ² filterarea, I S200 Vyon F. MFC					55	43164101
	Silo S200 för väggmontering, d76 suginlopp med fläns						43461007
	Triangulär ram för silo S200						43752001
	Ben rakt 1500 mm						43756001***
	Ben rakt 2200 mm						43756100***
	Stay-rör för ben L > 2200 mm						43757001****
					61		43834100

*Rekommenderas för filtermodul 43162101























**Rekommenderas för filtermodul 43164101

***Varje konfiguration behöver tre ben, dvs. för en komplett måste du beställa tre av samma artikelnummer



















****Används med 43756100, beställ tre st.

710A, Configurable.

710A, Configurable.

	Tillbehör	Artikelnummer
	Pneumatisk utloppsventil av fjärlstyp	43630500*
	Manuell utloppsventil	43630001**
	Strypventil DN65	43632001
	Handmanövrerad utloppsventil av fjärlstyp	43630400*
	Strypventil DN80	43632100
	Strypventil DN100	43632200
	Utloppsventil med motvikt	43630200**
	Utloppsventil, pneumatisk	43630100**
	Utloppsspjäll Linatex D100 set med Kanalanslutning för fläns	43630300
	Säckhållare för 43630200 eller 43631001	43640001
	Säckhållare för 43630100, för pneumatisk utloppsventil	43640003***
	Säckhållare big bag med pneumatisk utloppsventil	43640201
	Bagholder for big bag, MFC	43640217****
	Kontrollsystem för NE 22-76	43220026
	Kontrollsystem för NE86-96	43220008
	Kontrollsystem för NE 22-76	43220001
	Elektriskt styrsystem för ejektor NE 86-76. (Sugtid: 0-5 min, tömningstid: 0-15 s)	43222001
	Monteringsplåt för kontrollbox, S200	43690001
	Control system for ejectors	43220034
	Nivåkontroll för silo med kontinuerlig matning	43251001
	slang PU12 Ø51 L=10 m	43832600
	slang PU12 Ø51 L=5 m	43832500



710A, Configurable.

	Tillbehör	Artikelnummer
	slang PU12 Ø51 L=20 m	43832300
	slang PU12 Ø51 L=7,5 m med kopplingar	43832102*****
	Slang PU12 Ø51 L=10 m med kopplingar	43832200*****
	slang PU12 Ø63 L=5 m	43833200
	slang PU12 Ø63 L=10 m	43833001
	slang PU12 Ø63 L=20 m	43833100
	slang PU12 Ø76 L=10 m	43834200
	slang PU12 Ø76 L=20 m	43834300
	Golvstädset. Munstycke med hjul D-38mm och gummiläppar. Bredd 500mm. Anslutning D-51mm	42932100*****
	Golvstädset för torrtmaterial. Munstycke utan hjul med borstar. Bredd 400mm. Anslutning D-51mm	42932800*****
	Golvstädset. Munstycke med hjul D-65mm och gummiläppar. Bredd 400mm. Anslutning D-51mm	42932300*****
	Golvmunstycke, bredd 500 mm med små nylonhjul	43840150*****
	Golvmunstycke, bredd 400 mm med stora gummihjul	43840250*****
	Golvmunstycke bredd 400 mm utan hjul för torr sugning	43840550*****
	Handmunstycke, hård borste Ø90 mm	43860001*****
	Tandat munstycke bredd 130 mm	43861001*****
	Koniskt munstycke längd 250 mm	43862001*****
	Böj, Ø51 mm	43842150*****
	Städrör, längd 1100 mm, Ø51 mm	43842001*****
	Bulkmunstycke för golv, längd 1200 mm	43850150*****
	Bulkmunstycke längd 910 mm	43850001*****
	Skrapmunstycke, längd 1000 mm	43851150*****

710A, Configurable.

	Tillbehör	Artikelnummer
	Skrapmunstycke, längd 500 mm	43851050*****
	Stålspånmunstycke Ø50 mm, Ljuddämpat inlopp	40150030*****
	Golvmunstycke, bredd 500 mm, Ø63	43840400*****
	Bulkmunstycke längd 910 mm	43850050*****
	Bulkmunstycke L=910 mm för svivel	43850051*****
	Bulkmunstycke för golv, längd 1200 mm	43850200*****
	Handskrapmunstycke, längd 1000 mm	43851200*****
	Stådrör böj alum d63	43843050*****
	Svivel stål d63	43843100*****
	Stådrör aluminium Ø63	43843001*****
	Handskrapmunstycke, längd 500 mm	43851100*****
	Bulkmunstycke	43850100*****
	Bulkmunstycke med handtag	43850250*****
	Handskrapmunstycke, längd 1000 mm	43851250*****
	Reducering konisk d76-63, syrafast rostfritt stål	43880350
	Reducering konisk d76-51, syrafast rostfritt stål	43880300
	Slangreducering konisk d63-51	43880250
	Slangkoppling d63	43880100
	Slangkoppling d50	43880050
	Nivåindikator för dammtunna (BLI) EX	40375269
	Skarvhylsa d75-89/d53-63 mm	43884464
	Skarvhylsa d65-75	43884463

710A, Configurable.

	Tillbehör	Artikelnummer
	Skarvhylsa d98-114/d70-88	43884462
	Slangskarv d76, syrafast rostfritt stål	43880150
	Golvmunstycke d63/600	43840450*****

*Ø125 mm Hölje av NBR, pulverlackerat gjutjärn och klaff/hylsa i rostfritt stål. Temp. område - -20 till +120 °C. Höjd - 110 mm (260 mm i öppen position)

**Ø150 mm hölje och klaff i PA. Temp. område - -20 till +60 °C. Höjd - 155 mm (240 mm i öppen position)

***Rekommenderas för 43630100

****Can be used with valves 43630300, 43632001, 43632100, 43630201

*****Kopplingar medföljer, Ø51 mm

*****ATEX - Lämplig för brännbart damm med MIE (minsta tändenergi) <1 mJ. Säkerställ jordning av extraktorenhet. Får ej användas i atmosfärer med brännbar gas eller för utsugning av explosiva ämnen

*****ATEX - Denna produkten är lämplig att användas som rengöringsutrustning för brännbart damm med MIE (minsta tändenergi) <1 mJ. Produkten ska vara ordentligt jordad till extraktorenheten. Får ej användas i atmosfärer med brännbar gas eller för utsugning av explosiva ämnen

*****ATEX - Lämplig för brännbart damm (zon 20, 21, 22) och gas (zon 1, 2) av gruppen IIA, IIB och IIC. Säkerställ jordning till extraktorenhet. Får inte användas för utsugning av explosiva ämnen.

710A, Configurable.

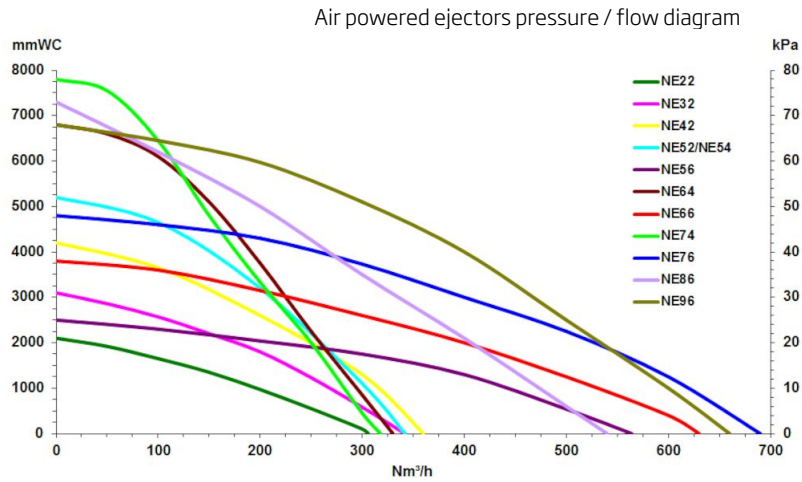

Air Powered ejectors

All performance data are based on 7 bar supply pressure

Ejector/Hose dimension	ø51mm	ø63mm	ø76mm
NE64	2	2,4	N/A
NE74	2,3	2,7	N/A
NE76	1,7	2,7	3,6
NE96	2,6	3,6	4,9

Capacity (tonne/hour) with Blasting media 2,4kg/liter and 20m hose

710A, Configurable.

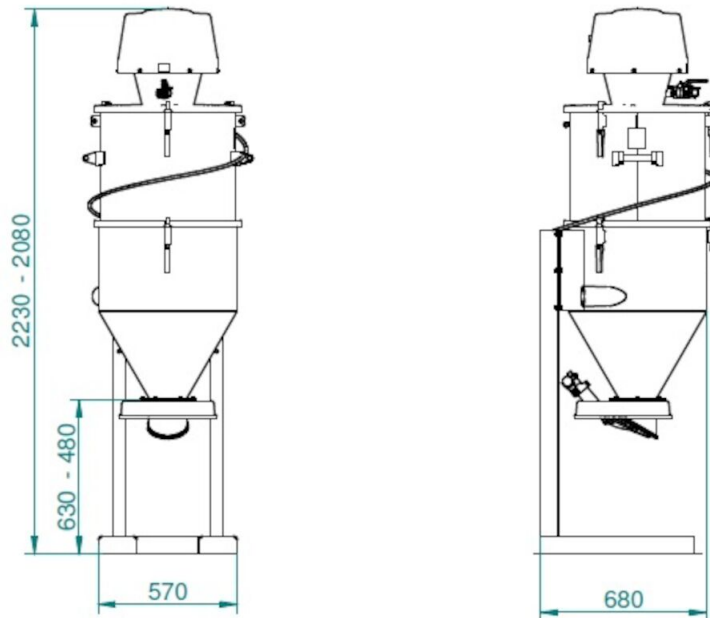

Dimensions - Filter part

710A, Configurable.

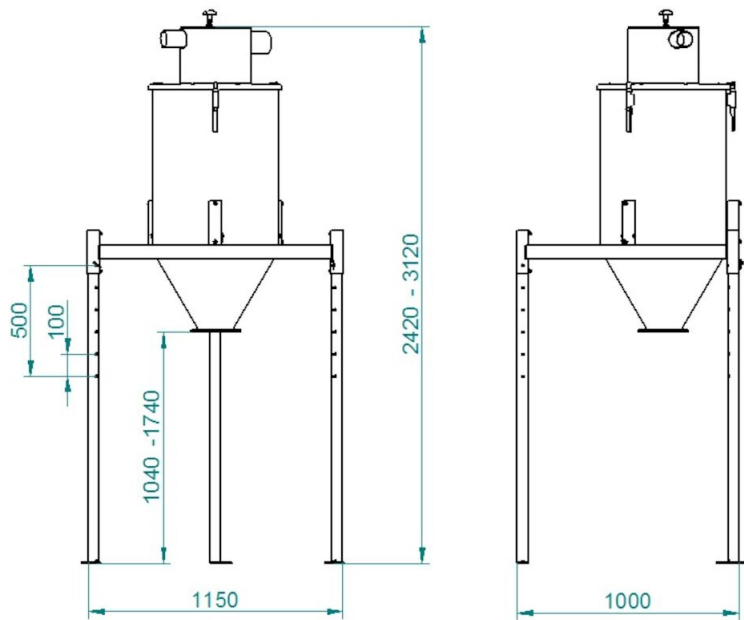

Dimensions pre-separation part