

## Nederman Fluid Management system (Safe record)

Liquid and oil monitoring system for improved profit and service for Vehicle Repair Shops.

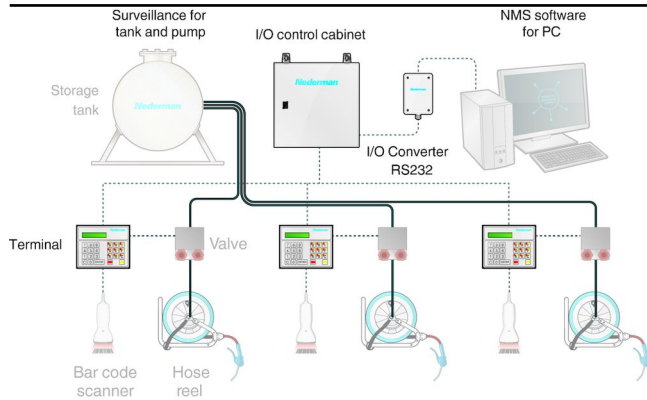

The NMS lubrication monitoring system for complete fluid control accurately monitors and supplies the correct amount of oils and liquids to each vehicle without manual handling or tapping. It also informs suppliers when it is time to refill tanks. This is the end of spillage, loss and unnecessary stoppages.

- Up to 250 delivery points
- Complete liquid control

<b>Product name</b>	Nederman Fluid Management system (Safe record)
---------------------	--









## Nederman Fluid Management system (Safe record)

פריט	Description	מחיר
	ST4-0 Fieldbus Converter K-32 + power supply EU + SafeRecord + oper.manuals	30512750
	ST4 Operator Terminal + 7 I/O ch.	30512850
	ST4 Operator Terminal	30512950
	ST4, 7 I/O channels	30513050
	ST4, 2 I/O channels	30513150
	Needed product to be able to set NMS in manual mode and open all outlets. Activated by included key.	30513450
	Saferecord software	30510150
	Saferecord pump control software	30510250
	Saferecord software GDS communication (activation with license key)	30510350
	Saferecord software TacDis communication (activation with license key)	30510450
	Saferecord software Kobra communication (activation with license key)	30510550
	Saferecord software Automaster communication (activation with license key)	30510650
	Saferecord software Dracar+ communication (activation with license key)	30510750
	Saferecord software SMC communication (activation with license key)	30510850
	Saferecord software WinAssist communication (activation with license key)	30510950

# Nederman Fluid Management system (Safe record)

אירוע	Description	מזה
	Saferecord software GDS communication (activation with license key)	30511050
	Software upgrade upgrade which allows SafeRecord to be run on computers using 64-bit OS.	30513750
	Saferecord software AutoLine communication (activation with license key)	30511150

## Nederman Fluid Management system (Safe record)

อุปกรณ์เสริม		หมายเลขชิ้นส่วน
	Valve unit 24V AC	30509650
	Valve unit for wind screen fluid	30509750
	Bar code reader	30509150
	Bus Expander R30	30513650
	Pressure transmitter 0-5mA 4-20mA	30511350
	Pressure transmitter 0-5m 4-20mA	30511451
	1/2" Ported solenoid valve	30507150
	Transformer 96VA 24VAC	30513250
	Transformer 220VA 24V AC/DC	30513350