

NCF fanları 50 Hz

















Nederman NCF Fanları, güvenli ve uygun maliyetli bir çalışma anlamına gelen doğrudan tahrik motorlarına sahiptir. Diğer Nederman ürünleriyle enerji tasarruflu bir NCF fanı takmak zaman kazandırır ve enerji maliyetlerini düşürür. Her türlü endüstriyel işlemlerde ve havalandırma sistemlerinde kullanılmak üzere tasarlanmış, kapalı ve açık alanlara monte edilebilen santrifüj fanıdır. Fan, standart olarak titreşim emicileri ile donatılmıştır

Medya	NCF fanları 50 Hz
Koruma sınıfı	IP 55
Kurulum	[Outdoor], [Indoor]
Materyal	Saç metal boyalı gri RAL 7045
Ambient temperature range	-30 to +40 °C (22 F to 104 F)
Operating Temperature	Maksimum 60 °C
Frekans(Hz)	50
Faz adedi	3



NCF fanları 50 Hz

[image]	Bilgi Dökümanı ismi	Güç Volt (V)	Amper(A)	Noise level (dB(A))	Ağırlık (kg)	Güç (kW)	[model]
	FAN NCF120/15	230/400	24,0/13,8	85 db(A) at 10000 m ³ /h	123	7,5	14550228
	FAN NCF30/15	230/400	7,9 / 4,6	69 db(A) at 2500 m ³ /h	67	2,2	14550128
	FAN NCF30/25	230/400	13,6/7,8	74 db(A) at 4000 m ³ /h	105	4	14550328
	FAN NCF40/25	230/400	17,9/10,3	75 db(A) at 4000 m ³ /h	110	5,5	14550428
	FAN NCF50/25	230/400	17,9/10,3	78 db(A) at 3500 m ³ /h	112	5,5	14550528
	FAN NCF80/20	230/400	24,0/13,8	77 db(A) at 6000 m ³ /h	150	7,5	14550628
	FAN NCF120/25	230/400	46,1/26,5	82 db(A) at 8000 m ³ /h	232	15	14550728
	FAN NCF160/25	230/400	56,5/32,5	84 db(A) at 10000 m ³ /h	292	18,5	14550828
	FAN NCF120/15	400/690	13,8/8,0	85 db(A) at 10000 m ³ /h	123	7,5	14550928
	FAN NCF30/25	400/690	7,8/4,5	74 db(A) at 4000 m ³ /h	105	4	14551028
	FAN NCF40/25	400/690	10,3/6,0	75 db(A) at 4000 m ³ /h	110	5,5	14551128
	FAN NCF50/25	400/690	10,3/6,0	78 db(A) at 3500 m ³ /h	112	5,5	14551228
	FAN NCF80/20	400/690	13,8/8,0	77 db(A) at 6000 m ³ /h	150	7,5	14551328
	FAN NCF120/25	400/690	26,5/15,3	82 db(A) at 8000 m ³ /h	232	15	14551428
	FAN NCF160/25	400/690	32,5/18,8	84 db(A) at 10000 m ³ /h	292	18,5	14551528

NCF fanları 50 Hz

	[accessory]	[partno]
	Giriş adaptörü d250,30/15,40/25,50/25	14374438
	Giriş adaptörü d315, 30/25	14374439
	Giriş adaptörü d400, 80/20, 120/25	14374440
	Giriş adaptörü d500, 120/15, 160/25	14374441
	Çıkış adaptörü.288x205 d315,30/15,40/25	14374442
	Çıkış adaptörü 322x229 d400, 30/25	14374443
	Çıkış adaptörü.361x256 d400,80/20,120/25	14374444
	Çıkış adaptörü.453x322d500,120/15,160/25	14374445
	Çıkış adaptörü.256x183 d250, 50/25,30/20	14374446
	esnek. Giriş adaptörü.d250,30/15,40/25,50/25	14374447
	Esnek giriş adaptörü d315, 30/25	14374448
	esnek. Giriş adaptörü d400, 80/20, 120/25	14374449
	esnek. Giriş adaptörü d500,120/15,160/25	14374450
	Esnek çıkış adaptörü 288x205 d315,30/15,40/25	14374451
	Esnek çıkış adaptörü 322x229 d400,30/25	14374452
	Esnek çıkış adaptörü 361x256d400,80/20,120/25	14374453
	Esnek çıkış adaptörü 453x322d500,120/15,160/25	14374454
	Esnek çıkış adaptörü 256x183 d250, 50/25,30/20	14374455
	Giriş koruyucu ağı d250,30/15,40/25,50/25	14374456
	Giriş Koruyucu ağı d315, 30/25	14374457
	Giriş Koruyucu ağı d400, 80/20, 120/25	14374458
	Giriş Koruyucu ağı d500,120/15,160/25	14374459

NCF fanları 50 Hz

	[accessory]	[partno]
	Çıkış koruyucu ağı, 30/15, 40/25	14374460
	Çıkış koruyucu ağı, 30/25	14374461
	Çıkış koruyucu ağı, 80/20, 120/25	14374462
	Çıkış koruyucu ağı, 120/15, 160/25	14374463
	Çıkış koruyucu ağı, 50/25	14374464
	Titreşim emici AM 40, 1 set	14374624
	Titreşim emici AM 30, 1 set	14374628
	Titreşim emici AM 25, 1 set	14374629
	Titreşim emici AM 50, 1 set	14374630
	Giriş adaptörü d250, 30/20	14375076
	Fan başlatıcı 5.5kW (2,2 - 5,5 kW motor gücü)	14514837
	Fan başlatıcı 11kW (4,0 - 11,0 kW motor gücü)	14514937
	Fan başlatıcı 18.5kW (15,0 - 18,5 kW motor gücü)	14515037
	Fan başlatıcı 22kW (18,5 - 22,0 kW motor gücü)	14515537
	5,5 kW motor gücü için Fan inverteri	14522037*
	7,5 kW motor gücü için Fan inverteri	14522137**
	11 kW motor gücü için Fan inverteri	14522237**
	15 kW motor gücü için Fan inverteri	14522637**
	18,5 kW motor gücü için Fan inverteri	14525137**
	22 kW motor gücü için Fan inverteri	14525237**

*Basınç sensörü 2000 Pa

**Basınç sensörü 5000 Pa

NCF fanları 50 Hz

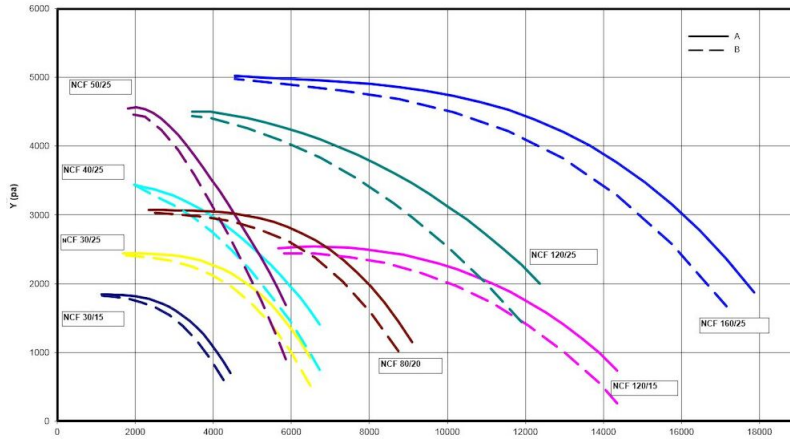

Y = Pressure drop

X = Air flow

A = Total pressure

B = Static pressure

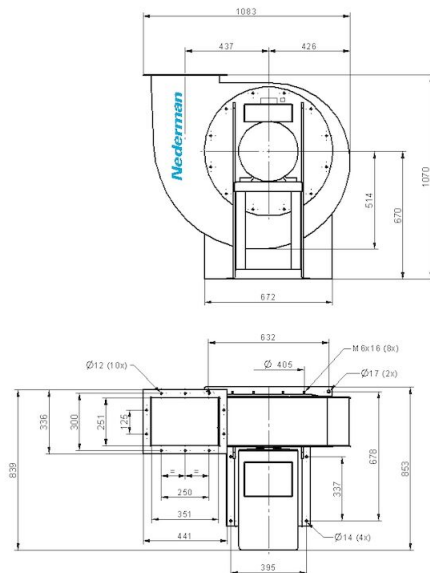

Fan NCF 120/25

Duct inlet diameter 400 mm

Duct outlet diameter 400 mm

NCF fanları 50 Hz

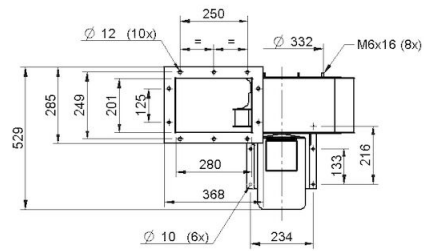
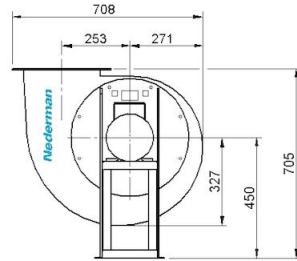

NCF 30/15

Duct inlet diameter 250 mm

Duct outlet diameter 315 mm

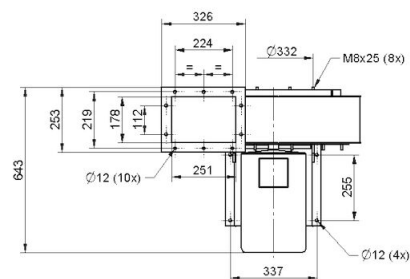
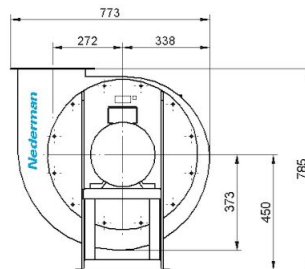

NCF 50/25

Duct inlet diameter 250 mm

Duct outlet diameter 250 mm

NCF fanları 50 Hz

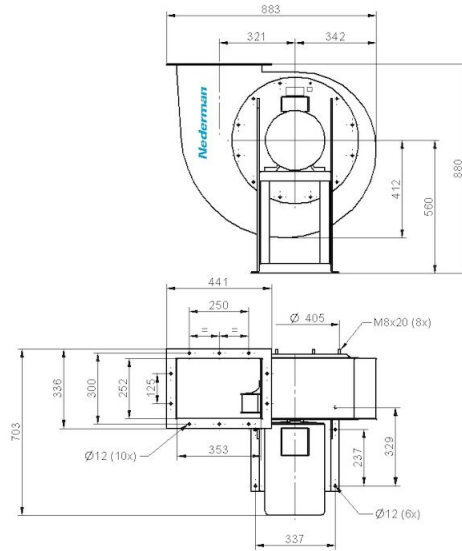

NCF 80/20

Duct inlet diameter 400 mm

Duct outlet diameter 400 mm

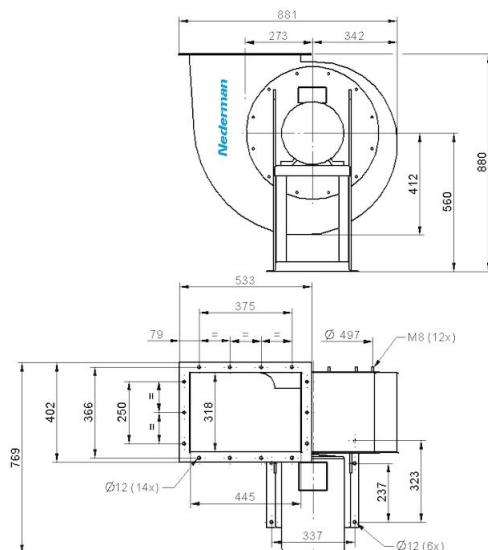

NCF 120/15

Duct inlet diameter 500 mm

Duct outlet diameter 500 mm

NCF fanları 50 Hz

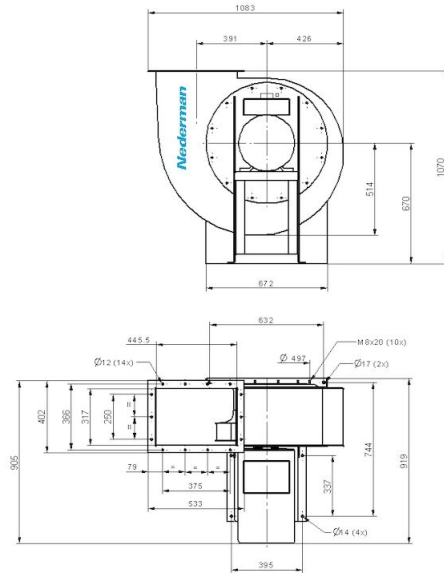

NCF 160/25

Duct inlet diameter 500 mm

Duct outlet diameter 500 mm

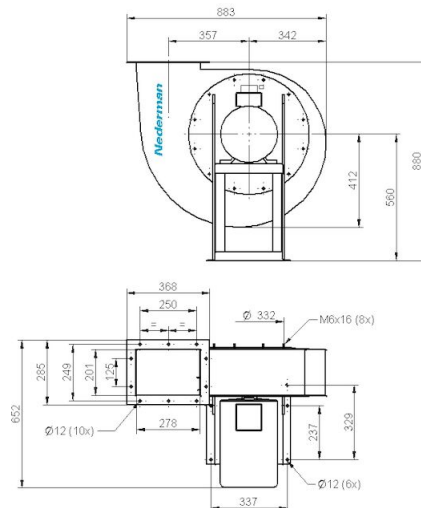

NCF 40/25

Duct inlet diameter 250 mm

Duct outlet diameter 315 mm

NCF fanları 50 Hz

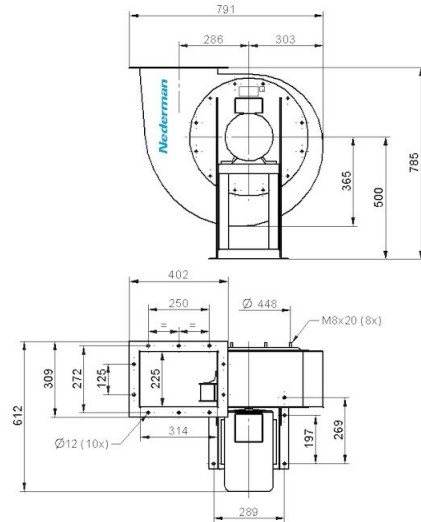

NCF 30/25

Duct inlet diameter 315 mm

Duct outlet diameter 400 mm