

QFS Nipler og tilbehør













Nipler og tilbehør til QF rørsystemer



Nipler og tilbehør til QFS rørsystemer

Produkt navn	QFS Nipler og tilbehør
Material	Galv
Sluttype A	QF
Længde	130
Længde (enhed)	m







QFS Nipler og tilbehør

Billede	Kort beskrivelse	Passende markeder	Legacy Item No.	Material Thickness	Diameter A	Vægt	Model
	End Cap QFS Galv 0,7mm 80QF	Europe (non UK)	LF22012-080	0,7mm	80	0,16	8210001050
	End Cap QFS Galv 0,7mm 100QF	Europe (non UK)	LF22012-100	0,7mm	100	0,06	8210001051
	End Cap QFS Galv 0,7mm 125QF	Europe (non UK)	LF22012-125	0,7mm	125	0,40	8210001052
	End Cap QFS Galv 0,7mm 140QF	Europe (non UK)	LF22012-140	0,7mm	140	0,46	8210001053
	End Cap QFS Galv 0,7mm 150QF	Europe (non UK)	LF22012-150	0,7mm	150	0,46	8210001054
	End Cap QFS Galv 0,7mm 160QF	Europe (non UK)	LF22012-160	0,7mm	160	0,34	8210001055
	End Cap QFS Galv 0,7mm 180QF	Europe (non UK)	LF22012-180	0,7mm	180	0,42	8210001056
	End Cap QFS Galv 0,7mm 200QF	Europe (non UK)	LF22012-200	0,7mm	200	0,60	8210001057
	End Cap QFS Galv 0,7mm 224QF	Europe (non UK)	LF22012-224	0,7mm	224	0,60	8210001058
	End Cap QFS Galv 0,7mm 250QF	Europe (non UK)	LF22012-250	0,7mm	250	0,68	8210001059
	End Cap QFS Galv 0,7mm 300QF	Europe (non UK)	LF22012-300	0,7mm	300	0,90	8210001060
	End Cap QFS Galv 0,7mm 315QF	Europe (non UK)	LF22012-315	0,7mm	315	0,95	8210001061
	End Cap QFS Galv 0,7mm 350QF	Europe (non UK)	LF22012-350	0,7mm	350	1,08	8210001062
	End Cap QFS Galv 0,9mm 400QF	Europe (non UK)	LF22012-400	0,9mm	400	1,36	8210001063
	Adapter Ventilation QFS Galv 0,7mm 80QF	Europe (non UK)	LF22014-080	0,7mm	80	0,16	8210000125

QFS Nipler og tilbehør

Billede	Kort beskrivelse	Passende markeder	Legacy Item No.	Material Thickness	Diameter A	Vægt	Model
	Adapter Ventilation QFS Galv 0,7mm 100QF	Europe (non UK)	LF22014-100	0,7mm	100	0,22	8210000126
	Adapter Ventilation QFS Galv 0,7mm 125QF	Europe (non UK)	LF22014-125	0,7mm	125	0,26	8210000127
	Adapter Ventilation QFS Galv 0,7mm 140QF	Europe (non UK)	LF22014-140	0,7mm	140	0,30	8210000128
	Adapter Ventilation QFS Galv 0,7mm 150QF	Europe (non UK)	LF22014-150	0,7mm	150	0,32	8210000129
	Adapter Ventilation QFS Galv 0,7mm 160QF	Europe (non UK)	LF22014-160	0,7mm	160	0,34	8210000130
	Adapter Ventilation QFS Galv 0,7mm 180QF	Europe (non UK)	LF22014-180	0,7mm	180	0,38	8210000131
	Adapter Ventilation QFS Galv 0,7mm 200QF	Europe (non UK)	LF22014-200	0,7mm	200	0,42	8210000132
	Adapter Ventilation QFS Galv 0,7mm 224QF	Europe (non UK)	LF22014-224	0,7mm	224	0,48	8210000133
	Adapter Ventilation QFS Galv 0,7mm 250QF	Europe (non UK)	LF22014-250	0,7mm	250	0,54	8210000134
	Adapter Ventilation QFS Galv 0,7mm 300QF	Europe (non UK)	LF22014-300	0,7mm	300	0,64	8210000135
	Adapter Ventilation QFS Galv 0,7mm 315QF	Europe (non UK)	LF22014-315	0,7mm	315	0,66	8210000136
	Adapter Ventilation QFS Galv 0,7mm 350QF	Europe (non UK)	LF22014-350	0,7mm	350	0,74	8210000137
	Adapter Ventilation QFS Galv 0,9mm 400QF	Europe (non UK)	LF22014-400	0,9mm	400	1,08	8210000138
	Adapter Machine Expanded QFS Galv 0,7mm 80QF L=0,13m	Europe (non UK)	LF22023-080	0,7mm	80	0,25	8210000038
	Adapter Machine Expanded QFS Galv 0,7mm 100QF L=0,13m	Europe (non UK)	LF22023-100	0,7mm	100	0,3	8210000039









QFS Nipler og tilbehør

Billede	Kort beskrivelse	Passende markeder	Legacy Item No.	Material Thickness	Diameter A	Vægt	Model
	Adapter Machine Expanded QFS Galv 0,7mm 125QF L=0,13m	Europe (non UK)	LF22023-125	0,7mm	125	0.38	8210000040
	Adapter Machine Expanded QFS Galv 0,7mm 140QF L=0,13m	Europe (non UK)	LF22023-140	0,7mm	140	0.43	8210000041
	Adapter Machine Expanded QFS Galv 0,7mm 150QF L=0,13m	Europe (non UK)	LF22023-150	0,7mm	150	0.45	8210000042
	Adapter Machine Expanded QFS Galv 0,7mm 160QF L=0,13m	Europe (non UK)	LF22023-160	0,7mm	160	0.48	8210000043
	Adapter Machine Expanded QFS Galv 0,7mm 180QF L=0,13m	Europe (non UK)	LF22023-180	0,7mm	180	0.58	8210000044
	Adapter Machine Expanded QFS Galv 0,7mm 200QF L=0,13m	Europe (non UK)	LF22023-200	0,7mm	200	0.63	8210000045
	Adapter Machine Expanded QFS Galv 0,7mm 224QF L=0,13m	Europe (non UK)	LF22023-224	0,7mm	224	0.7	8210000046
	Adapter Machine Expanded QFS Galv 0,7mm 250QF L=0,13m	Europe (non UK)	LF22023-250	0,7mm	250	0.8	8210000047
	Adapter Machine Expanded QFS Galv 0,7mm 300QF L=0,13m	Europe (non UK)	LF22023-300	0,7mm	300	0.98	8210000048
	Damper QFS Manual 100QF	Europe (non UK)	LF23005-100		100	6,00	8210000805
							8210000806*
	Damper QFS Manual 160QF	Europe (non UK)	LF23005-150		160	7,00	8210003389
	Damper QFS Manual 200QF	Europe (non UK)	LF23005-200		200	9,00	8210000807
	Damper QFS Manual 250QF	Europe (non UK)	LF23005-250		250	10,00	8210000808
	Damper QFS Manual 300QF	Europe (non UK)	LF23005-300		300	10,00	8210000809

QFS Nipler og tilbehør

Billede	Kort beskrivelse	Passende markeder	Legacy Item No.	Material Thickness	Diameter A	Vægt	Model
	Damper QFS Manual 350QF	Europe (non UK)	LF23005-350		350	11,5	8210000810
	Damper QFS Manual 400QF	Europe (non UK)	LF23005-400		400	11,5	8210000811
	Damper QFS Automatic 100QF	Europe (non UK)	LF23010-100		100	7,50	8210000798
							8210000799**
	Damper QFS Automatic 160QF	Europe (non UK)	LF23010-160		160	8,50	8210003390
	Damper QFS Automatic 200QF	Europe (non UK)	LF23010-200		200	10,50	8210000800
	Damper QFS Automatic 250QF	Europe (non UK)	LF23010-250		250	11,50	8210000801
	Damper QFS Automatic 300QF	Europe (non UK)	LF23010-300		300	11,50	8210000802
	Damper QFS Automatic 350QF	Europe (non UK)	LF23010-350		350	13,00	8210000803
	Damper QFS Automatic 400QF	Europe (non UK)	LF23010-400		400	13,00	8210000804
	Oil Mist Drain QFS Galv 0,9mm 80QF	Europe (non UK)	LF23020-080	0,9mm	80	4,50	8210001134
	Oil Mist Drain QFS Galv 0,9mm 100QF	Europe (non UK)	LF23020-100	0,9mm	100	4,30	8210001135
	Oil Mist Drain QFS Galv 0,9mm 125QF	Europe (non UK)	LF23020-125	0,9mm	125	4,30	8210001136
	Oil Mist Drain QFS Galv 0,9mm 140QF	Europe (non UK)	LF23020-140	0,9mm	140	4,30	8210001137
	Oil Mist Drain QFS Galv 0,9mm 150QF	Europe (non UK)	LF23020-150	0,9mm	150	10,50	8210001138

QFS Nipler og tilbehør

Billede	Kort beskrivelse	Passende markeder	Legacy Item No.	Material Thickness	Diameter A	Vægt	Model
	Oil Mist Drain QFS Galv 0,9mm 160QF	Europe (non UK)	LF23020-160	0,9mm	160	10,50	8210001139
	Oil Mist Drain QFS Galv 0,9mm 180QF	Europe (non UK)	LF23020-180	0,9mm	180	10,50	8210001140
	Oil Mist Drain QFS Galv 0,9mm 200QF	Europe (non UK)	LF23020-200	0,9mm	200	10,50	8210001141
	Oil Mist Drain QFS Galv 0,9mm 224QF	Europe (non UK)	LF23020-224	0,9mm	224	10,50	8210001142
	Oil Mist Drain QFS Galv 0,9mm 250QF	Europe (non UK)	LF23020-250	0,9mm	250	10,50	8210001143
	Oil Mist Drain QFS Galv 0,9mm 300QF	Europe (non UK)	LF23020-300	0,9mm	300	18,00	8210001144
	Oil Mist Drain QFS Galv 0,9mm 315QF	Europe (non UK)	LF23020-315	0,9mm	315	18,00	8210001145
	Oil Mist Drain QFS Galv 0,9mm 350QF	Europe (non UK)	LF23020-350	0,9mm	350	18,00	8210001146
	Oil Mist Drain QFS Galv 0,9mm 400QF	Europe (non UK)	LF23020-400	0,9mm	400	18,00	8210001147

*Manual Damper

**Automatic Damper

QFS Nipler og tilbehør

QF Machine adapter dimensions

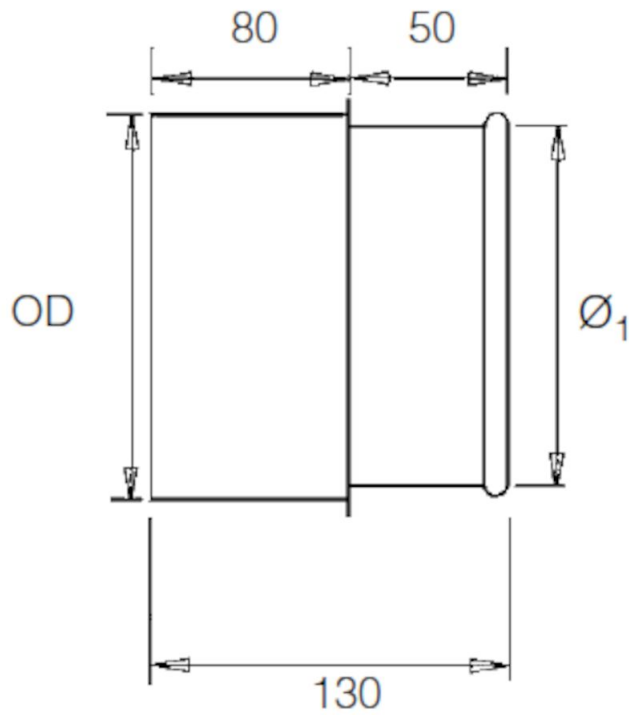

QF Machine adapter dimensions

QFS Nipler og tilbehør

QF Ventilation adapter

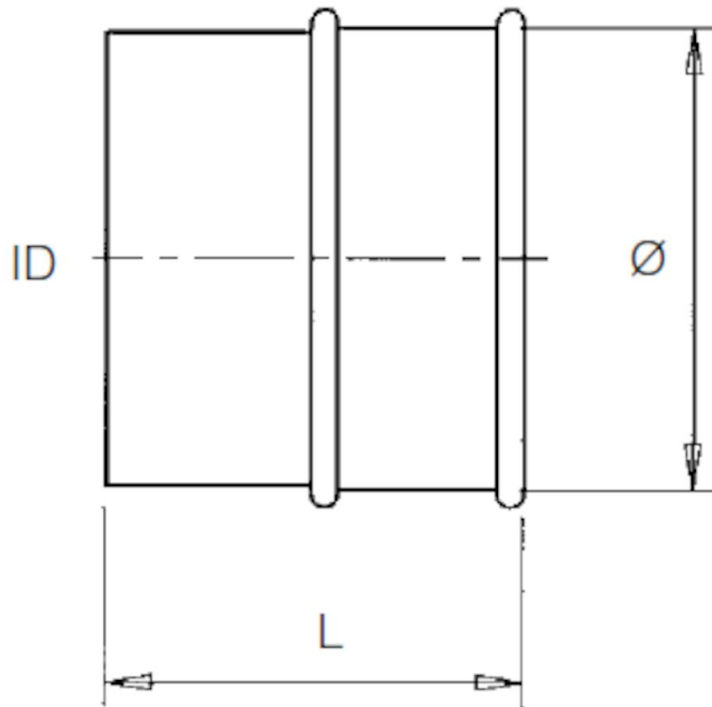

QF Ventilation adapter

QFS Nipler og tilbehør

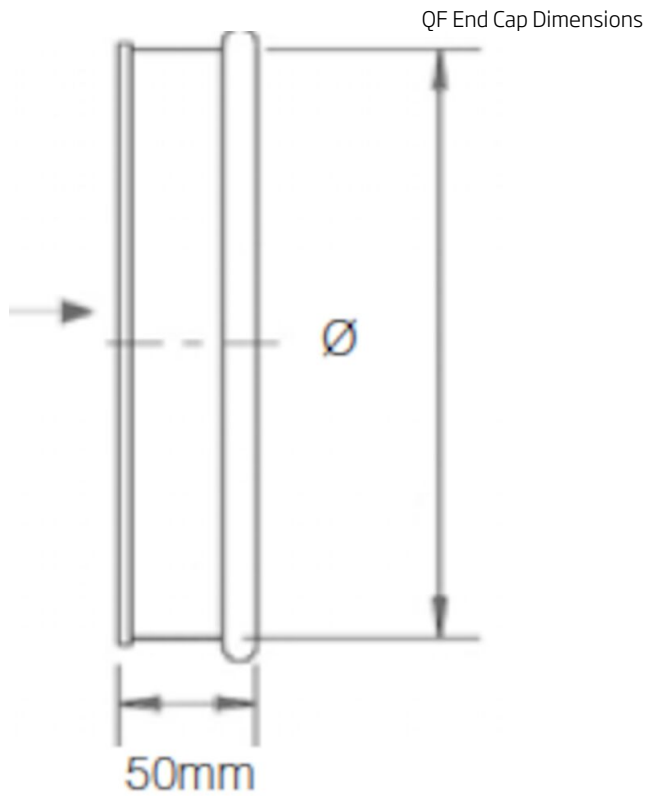

QF End Cap Dimensions, 22012-XXX

