

QFS адапторы и аксессуары

Адаптеры и различное вспомогательное оборудование для QFS (Быстрой Сборки Герметичный) системы воздуховодов

















Наименование товара	QFS адапторы и аксессуары
---------------------	---------------------------















QFS адапторы и аксессуары

[image]	Название листа технических данных	диаметр (mm)	Length (m)	Вес (кг)	Thickness (mm)	[model]
		80		0,09	0,7	8210001050
		100		0,13	0,7	8210001051
		125		0,18	0,7	8210001052
		140		0,22	0,7	8210001053
		150		0,24	0,7	8210001054
		160		0,26	0,7	8210001055
		180		0,35	0,7	8210001056
		200		0,4	0,7	8210001057
		224		0,49	0,7	8210001058
		250		0,62	0,7	8210001059
		300		0,88	0,7	8210001060
		315		1,15	0,7	8210001061
		350		1,6	0,7	8210001062
		400		2,12	0,9	8210001063
		80				8210000125















QFS адапторы и аксессуары

[image]	Название листа технических данных	диаметр (mm)	Length (m)	Вес (кг)	Thickness (mm)	[model]
		100				8210000126
		125				8210000127
		140				8210000128
		150				8210000129
		160				8210000130
		180				8210000131
		200				8210000132
		224				8210000133
		250				8210000134
		300				8210000135
		315				8210000136
		350				8210000137
		400				8210000138
						8210000038
						8210000039









QFS адапторы и аксессуары

[image]	Название листа технических данных	диаметр (mm)	Length (m)	Вес (кг)	Thickness (mm)	[model]
						821000040
						821000041
						821000042
						821000043
						821000044
						821000045
						821000046
						821000047
						821000048
		100	185	6		821000805*
		150		7		821000806*
		160	385	7		8210003389*
		200	185	9		821000807*
		250	185	10		821000808*
		300	185	10		821000809*

QFS адапторы и аксессуары

[image]	Название листа технических данных	диаметр (mm)	Length (m)	Вес (кг)	Thickness (mm)	[model]
		350	485	11,5		8210000810*
		400	485	11,5		8210000811*
		100	185	7,5		8210000798**
		150		8,5		8210000799**
		160	385	8,5		8210003390**
		200	185	10,5		8210000800**
		250	185	11,5		8210000801**
	LCP 11-44 For dry dust	300	185	11,5		8210000802**
		350	485	13		8210000803**
		400	485	13		8210000804**
		80			0,9	8210001134
		100			0,9	8210001135
		125			0,9	8210001136
		140			0,9	8210001137
		150			0,9	8210001138

QFS адапторы и аксессуары

[image]	Название листа технических данных	диаметр (mm)	Length (m)	Вес (кг)	Thickness (mm)	[model]
		160			0,9	8210001139
		180			0,9	8210001140
		200			0,9	8210001141
		224			0,9	8210001142
		250			0,9	8210001143
		300			0,9	8210001144
		315			0,9	8210001145
		350			0,9	8210001146
		400			0,9	8210001147

*Manual Damper

**Automatic Damper

QFS адапторы и аксессуары

QF Machine adapter dimensions

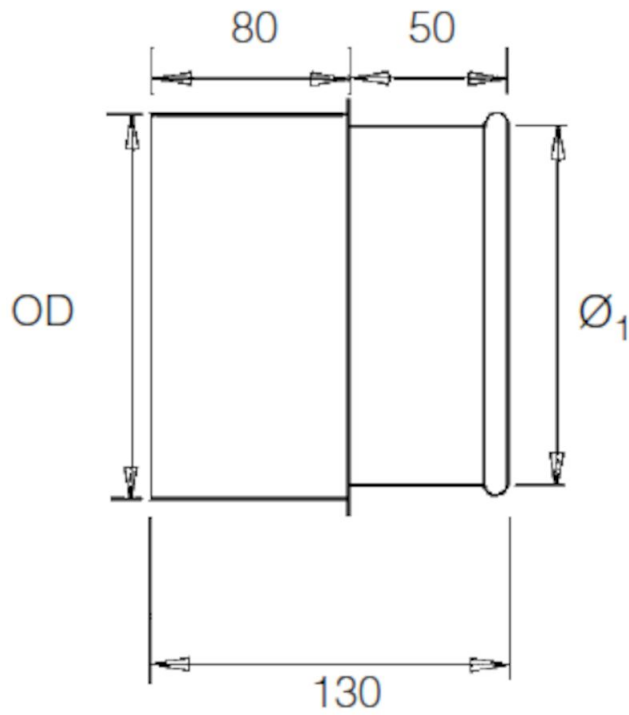

QF Machine adapter dimensions

QFS адапторы и аксессуары

QF Ventilation adapter

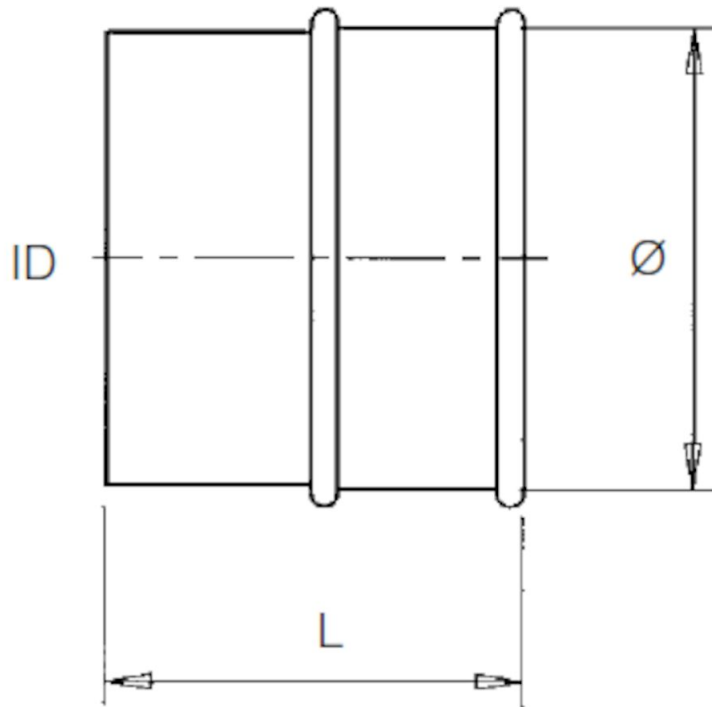

QF Ventilation adapter

QFS адапторы и аксессуары

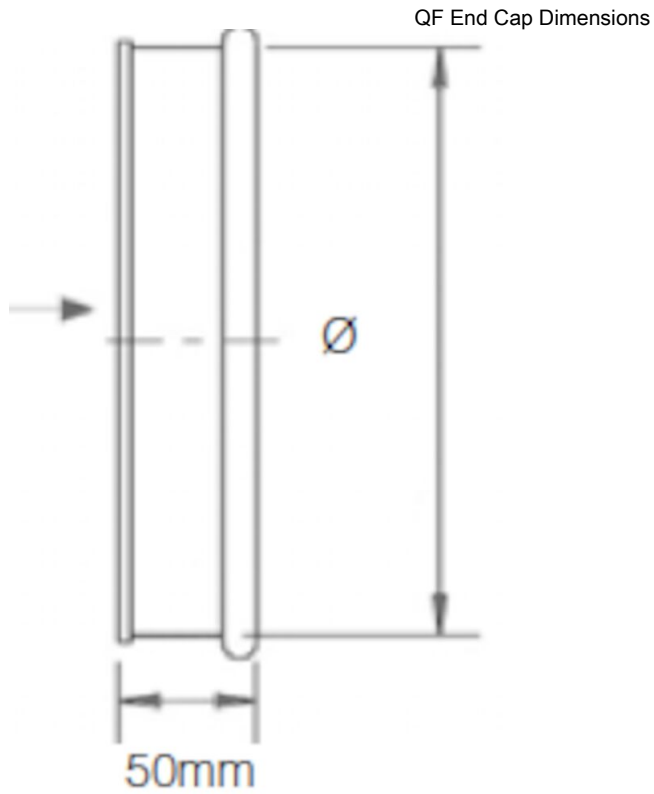

QF End Cap Dimensions, 22012-XXX

