

OMF 2x6000 SM

FibreDrain® oljetåke oppsamler for kontinuerlig drift.



Nederman OMF oljetåkeliminertor er utformet for å håndtere store mengder damp under kontinuerlig drift. De er utviklet med fokus på høyeffektiv filtrering med lave vedlikeholdskostnader.



Nederman OMF 2x6000 har som standard tre filternivåer der de to første nivåene består av filterkassetter med Nedermans FibreDrain®-teknologi. Nederman har et bredt spekter av ulike typer filtre for mange ulike typer programmer. Det tredje nivået består av et HEPA-filte i filterklassen H13 med en virkningsgrad på 99,95 % for MPPS iht. EN1822. Alle Nederman OMF-enhetene er klargjort for bruk av pre-filteet.

- Tre filternivåer, valgfritt forfilter
- Målere for lesing av trykkfall ved hvert filtertrinn
- Drain: 4 off 1 1/2"
- Non-vibration fan suspension system

Produktnavn	OMF 2x6000 SM
Standard	2009/125/EC
Volum (for frakt) (m ³)	15.4
Støynivå (dB(A))	< 70 dB(A) @1,5 m fra serviceside med ekstra lyddempet viftehus og lyddemper
Beskyttelsesklasse:	IP55
Filtereffektivitet (%)	99,95
Installasjon	Innendørs
Materiale	Metallplater malt både innvendig og utvendig
Rengjøringsmetode, filter	Automatisk filter rens
Arbeidstrykk (kPa)	Max 4600 Pa
Kapasitet (maks. luftstrøm m ³ /t)	12000
Driftstemperatur	60°C (begrænset af filter)
Spenning (V)	400/690
Frekvens Hz	50
Antall faser	3
Antall filterelementer	18
Strømstyrke (A)	26 / 15,1
Farge	NCS-S 1005 B20G
Vekt (kg)	1810
Kraft (kW)	15
Avklaring av teknisk informasjon	Plus seks filter element som option















OMF 2x6000 SM

Bilde	Navn på datablad	Model
	OMF 2x6000, Innløpsflens 560x560mm venstre. Utløp 4 x 1 ½" Hun.	12401155*
	OMF 2x6000, Innløpsflens 560x560mm høyre. Utløp 4 x 1 ½" Hun.	12401156*

**Plus seks filter element som option*

OMF 2x6000 SM

Tilbehør		Artikkelnummer
	Avløpspumpeboks, 50 Hz	12400054*
	Drain container with piping	12400764**
	Forfilter ORF 610x610x96	12400039
	Filter 1 emulsjon (OMF2000,4000,6000)	12400009
	Filter 2 emulsjon (OMF2000,4000,6000))	12400010
	HEPA-filter	12400012
	Inlet adapter OSF 4x3000, OMF 3x4000, OMF 2x6000	12401163
	Extension structure OMF 2x6000	12401169
	Fan enclosure 3 filters in depth	12401160
	Silencer 90° Ø 630 mm	12401159
	Drain pump box, 50 Hz, 10 litre/min at 10m, including controller	12401330
	OSF/OMF Instruction manual for mounting system for electric components	12401342
	OMF/OSF/MQL mounting system for electrical components	12401341

*Drain connection must be elevated min 200 mm from pump box support level

**Drain connection must be elevated min 420mm from container support level

OMF 2x6000 SM

OMF 2x6000 assembly of options:



OMF 2x6000 SM

OMF 2x6000 complete with options:



OMF 2x6000 SM

OMF 2x6000 with inlet from left side:

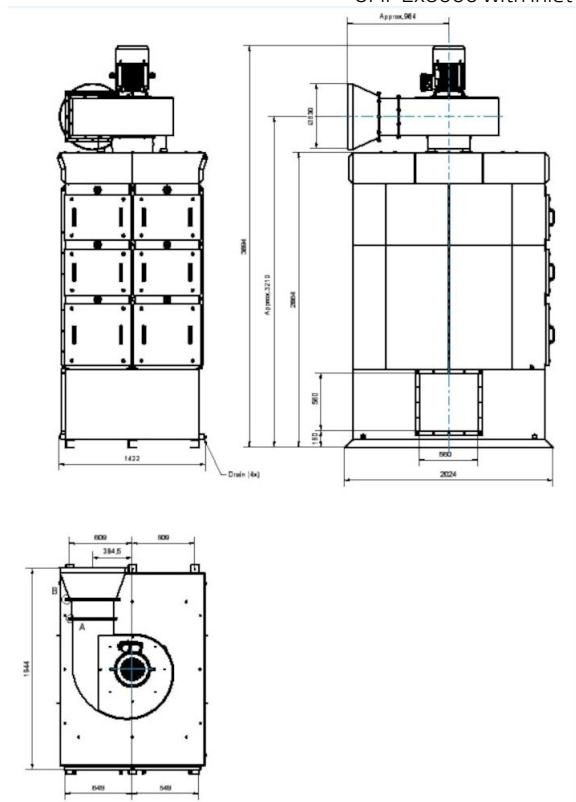

OMF 2x6000 SM

OMF 2x6000 with inlet from right side:

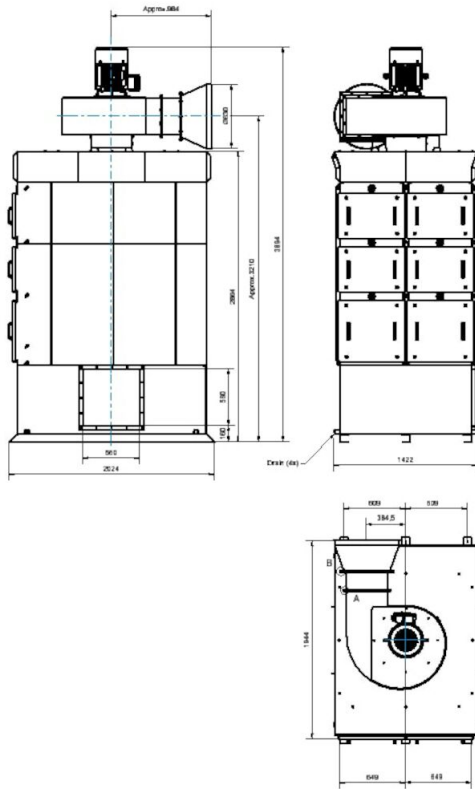

OMF 2x6000 SM

Dimension Inlet Adapter OSF4x3000_OMF3x4000_2x6000,
accessory 12401163:

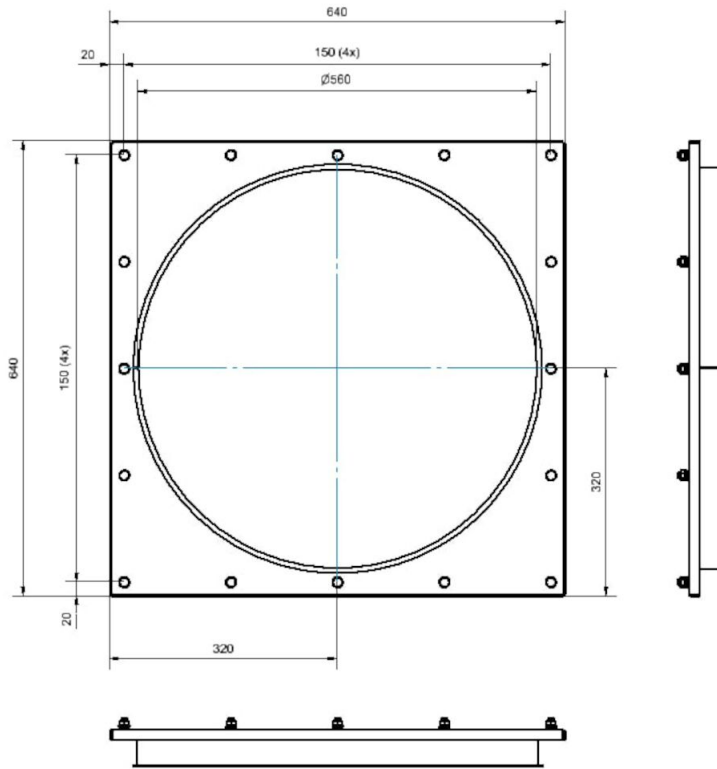

OMF 2x6000 SM

Dimension Extensions Structure OMF2x6000,
accessory 12401169:

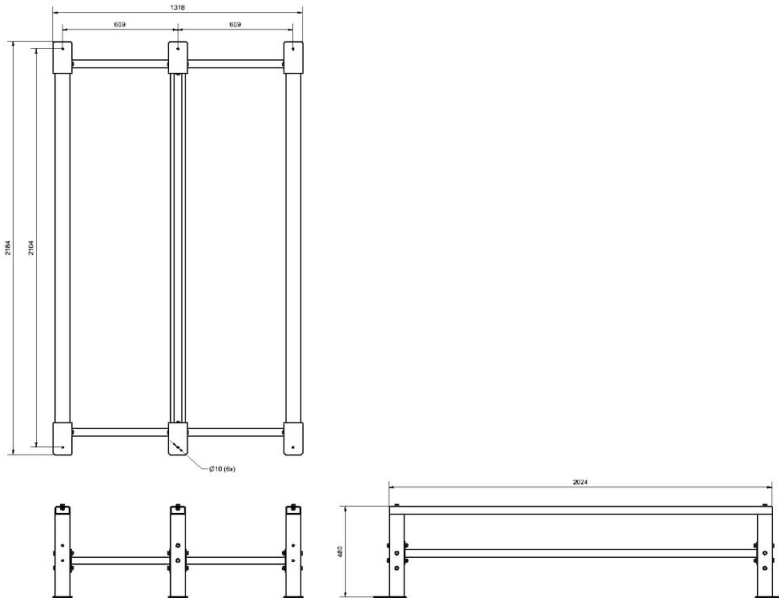

Dimension Fan Enclosure OSF4x3000_OMF2x6000,
accessory 12401160:

