

OMF 2x6000 SM

FibreDrain 可持续运行的油雾收集设备



尼的曼OMF，油雾过滤器为处理持续运行中产生的大量纯油雾而设计，为高效过滤且低维护成本而研发。

尼的曼标准 OMF 2x6000 有三级滤芯单元，其中上两级单元由尼的曼的FibreDrain专利技术的滤芯单元组成

尼的曼Nederman有各种不同类型的过滤单元来适配各种不同应用。第三级滤芯单元由一个H13的HEPA滤芯组成，根据EN1822，对MPPS的过滤效率达99.95%。所有尼的曼 OMF 为竖直结构，并且可以根据需要配置预过滤单元。OMF 2x6000 顶部装有离心风机。

三级滤芯单元，可选预过滤

观测每层滤芯单元的压强下降

Drain: 4 off 1 1/2"

Non-vibration fan suspension system

品名	OMF 2x6000 SM
标准	2009/125/EC
体积（运输时）（立方米）	15.4
噪音水平（分贝）	<70 dB(A) @1,5 m from service side with optional fan enclosure and silencer
保护等级	IP55
过滤效能（%）	99,95
安装	室内
材料	金属板，内外粉刷
清灰方式	自动排水
工作压力（干帕）	Max 4600 Pa
性能（最大风量m3/h）	12000
工作温度	60 deg C (limited by filter)
电压（V）	400/690
频率（Hz）	50
电源相数	3
滤芯数量	18
安培数（安）	26 / 15,1
颜色	NCS-S 1005 B20G
重量（公斤）	1810
功率（kW）	15
技术数据声明	Plus 6可选过滤项











OMF 2x6000 SM

[image]	产品名称	产品编号
	OMF 2x6000, Inlet flange 560x560mm left. Drain 4 x 1 " Female.	12401155*
	OMF 2x6000, Inlet flange 560x560mm right. Drain 4 x 1 " Female.	12401156*

*Plus 6可选过滤项

OMF 2x6000 SM

	附件	产品编号
	排水泵箱, 50 Hz	12400054*
	Drain container with piping	12400764**
	预滤器, ORF 610x610x96	12400039
	过滤器 1, 乳化液 (OMF2000, 4000, 6000)	12400009
	过滤器 2, 乳剂 (OMF2000, 4000, 6000)	12400010
	HEPA, 过滤器	12400012
	Inlet adapter OSF 4x3000, OMF 3x4000, OMF 2x6000	12401163
	Extension structure OMF 2x6000	12401169
	Fan enclosure 3 filters in depth	12401160
	Silencer 90° 630 mm	12401159
	Drain pump box, 50 Hz, 10 litre/min at 10m, including controller	12401330
	OSF/OMF Instruction manual for mounting system for electric components	12401342
	OMF/OSF/MQL mounting system for electrical components	12401341

*Drain connection must be elevated min 200 mm from pump box support level

**Drain connection must be elevated min 420mm from container support level

OMF 2x6000 SM

OMF 2x6000 assembly of options:



OMF 2x6000 SM

OMF 2x6000 complete with options:



OMF 2x6000 SM

OMF 2x6000 with inlet from left side:

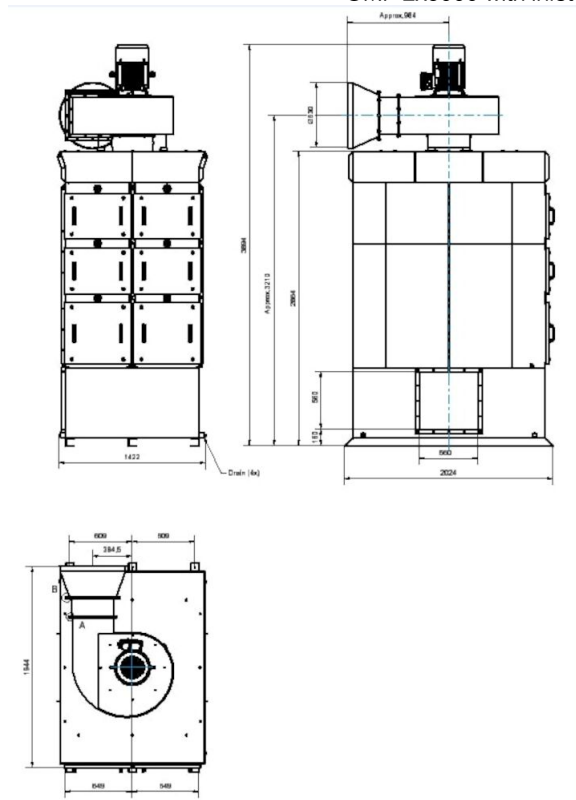

OMF 2x6000 SM

OMF 2x6000 with inlet from right side:

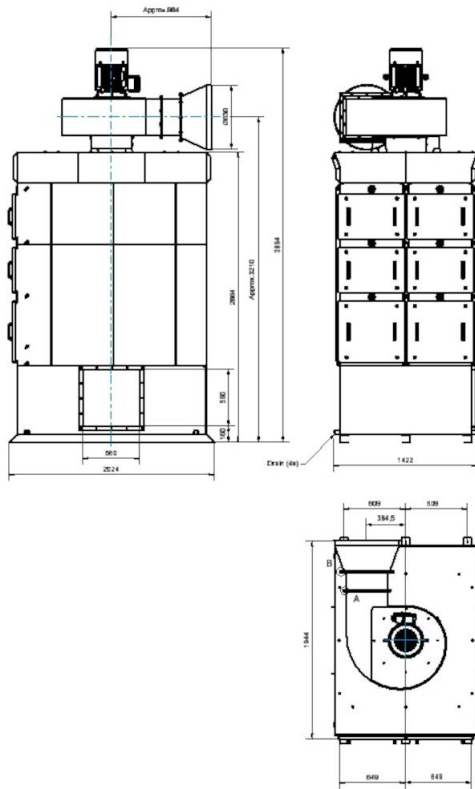

OMF 2x6000 SM

Dimension Inlet Adapter OSF4x3000_OMF3x4000_2x6000,
accessory 12401163:

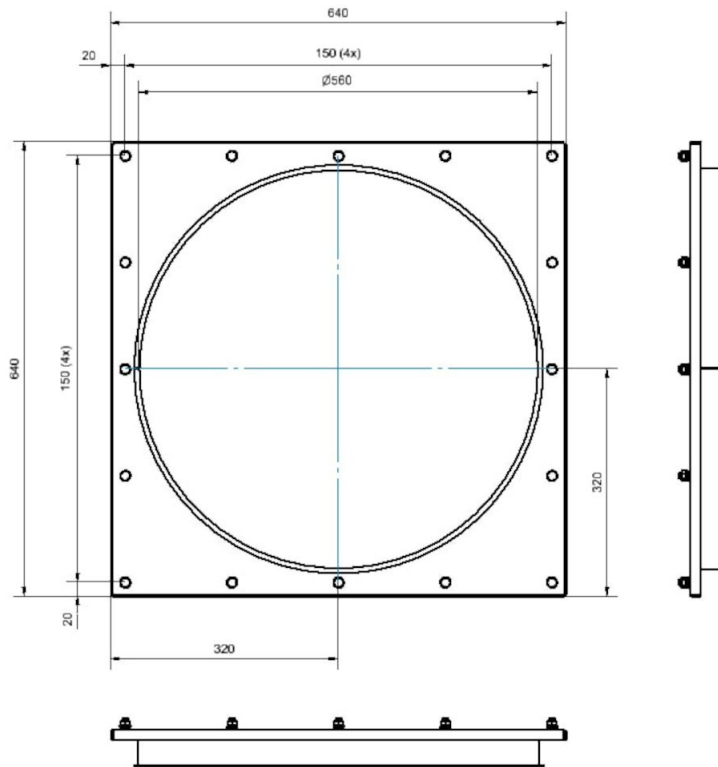

OMF 2x6000 SM

Dimension Extensions Structure OMF2x6000,
accessory 12401169:

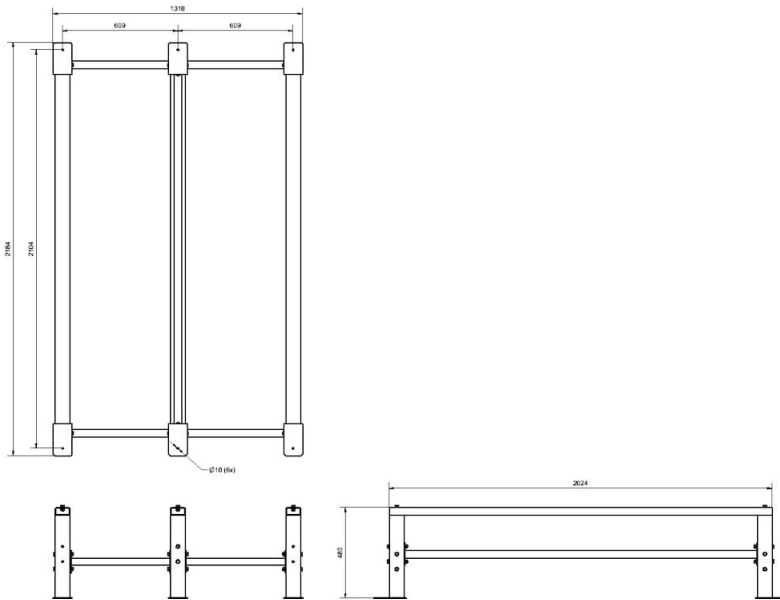

Dimension Fan Enclosure OSF4x3000_OMF2x6000,
accessory 12401160:

