

OSF 5x2000 SM

FibreDrain® oil smoke collector for continuous operation.



Nederman OSF oil smoke collectors are designed to handle large amounts of neat oil mist during continuous operation. They are developed with focus on high efficient filtration together with low maintenance cost.



Nederman OSF 5x2000 has as standard 3 filter-stages where the first 2 stages consists of filter cassettes with Nederman's FibreDrain® technology. Nederman have a wide range of different types of filters to suit many different kind of applications. The third stage consists of a HEPA filter in filter class H13 with an efficiency of 99,95% for MPPS according to EN1822. All tower built Nederman OSF units are prepared for use of pre filter. OSF 5x2000 have a top mounted radial fan.

- Three filter stages, optional pre-filter
- Gauges for reading of pressure drop over each filter stage
- Drain: 4 off 1 1/2"
- Non-vibration fan suspension system

Product name	OSF 5x2000 SM
Standard	2009/125/EC
Volume (for shipping) (m³)	23.5
Noise level (dB(A))	< 70 dB(A) @1,5 m from service side with optional fan enclosure and silencer
Protection class	IP55
Filter efficiency (%)	99,95
Installation	[Indoor]
Material	Sheet metal, painted both in- and outside.
Filter cleaning method	Self-Draining
Working pressure (kPa)	Max 4600 Pa
Capacity (max airflow m³/h)	10000
Operating Temperature	60 deg C (limited by filter)
Power Voltage (V)	400/690
Frequency (Hz)	50
No of phases	3
Number of filter elements	30
Amperage (A)	26/15,1
Colour	NCS-S 1005 B20G
Weight (kg)	4270
Power (kW)	15
Note	Plus 10 optional filter element.













OSF 5x2000 SM

Image	Description	Model
	OSF 5x2000, Inlet flange 500x500mm left. Drain 4 x 1 1/2" Female.	12401147*
	OSF 5x2000, Inlet flange 500x500mm right. Drain 4 x 1 1/2" Female.	12401148*

*Plus 10 optional filter element.

OSF 5x2000 SM

	Accessory	Part No
	Drain pump box, 50 Hz	12400054*
	Drain container with piping	12400764**
	Optional FibreDrain Pre Filter ORF 610x610x96 mm.	12400039
	FibreDrain Filter 1 OSF; 600x600x292 mm	12400006
	FibreDrain Filter 2 OSF; 600x600x292 mm	12400007
	HEPA Filter H13 610x610x292 mm	12400012
	Inlet adapter OSF 5x2000	12401162
	Extension structure OSF 5x2000	12401167
	Fan enclosure 2 filters in depth	12401109
	Silencer 90° Ø 630 mm	12401159
	Drain pump box, 50 Hz, 10 litre/min at 10m, including controller	12401330

*Drain connection must be elevated min 200 mm from pump box support level

**Drain connection must be elevated min 420mm from container support level

OSF 5x2000 SM

OSF 5x2000 assembly of options:



OSF 5x2000 SM

OSF 5x2000 complete with options:

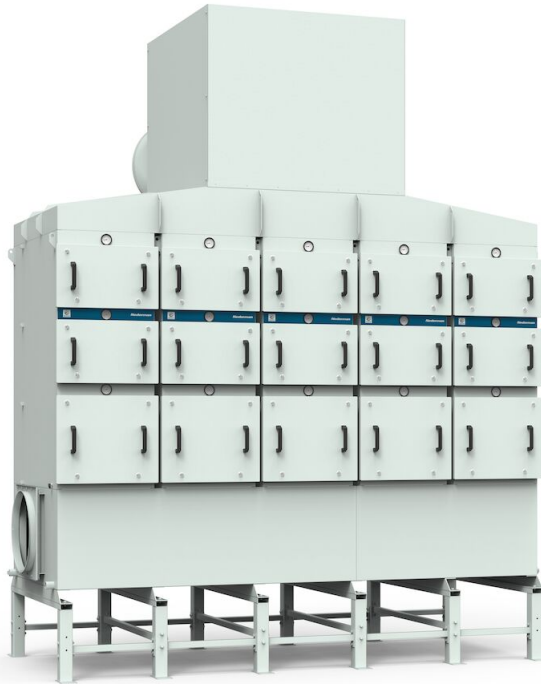

OSF 5x2000 SM

OSF 5x2000 with inlet from right side:

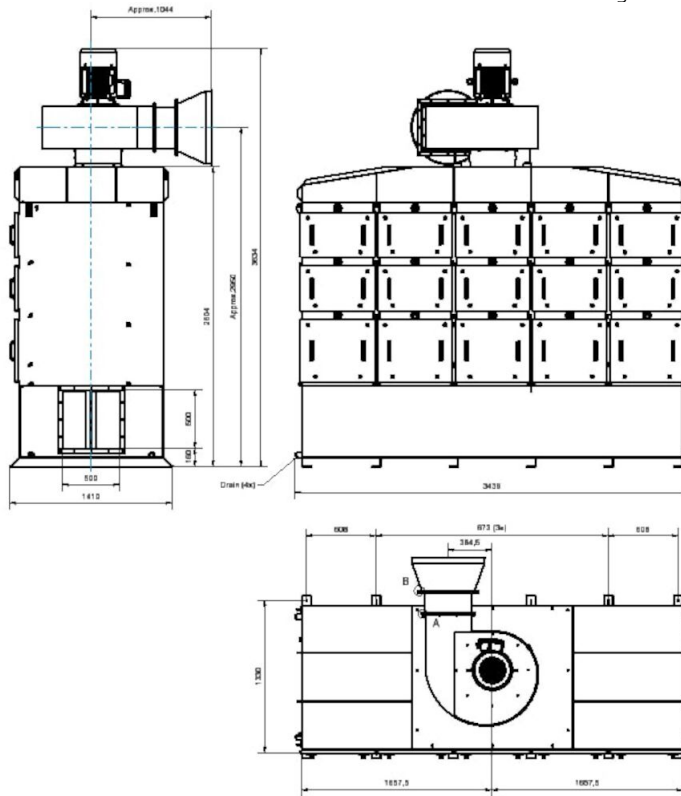

OSF 5x2000 SM

Dimension Inlet adapter OSF5x2000,
accessory 12401162:

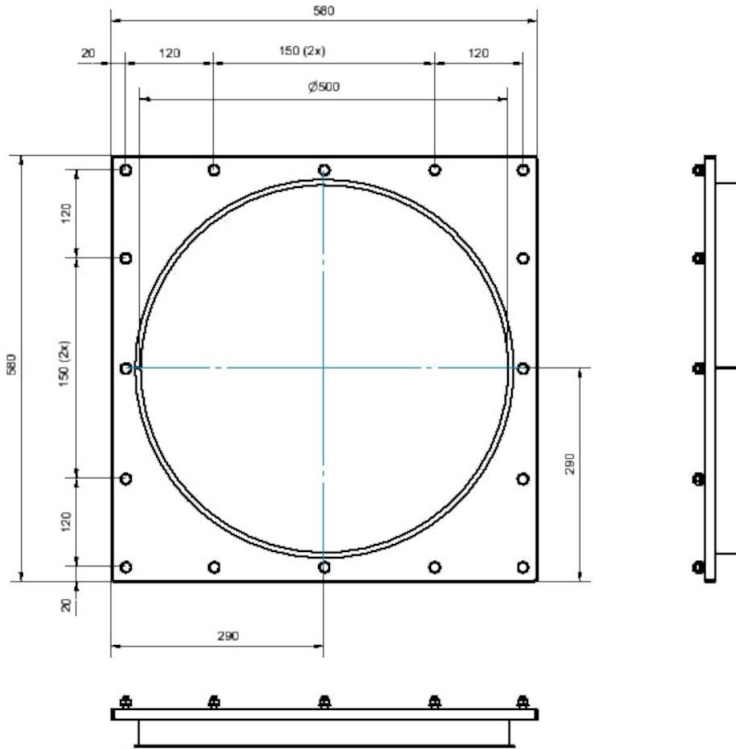

Dimension Extensions Structure OMF2x6000,
accessory 12401167:

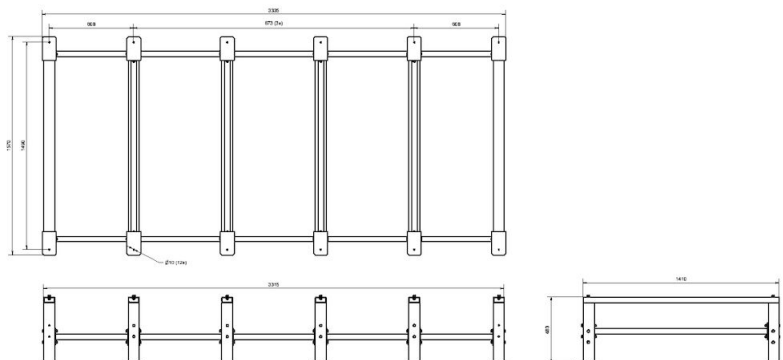

OSF 5x2000 SM

Dimension Fan Enclosure_OSF2x2000_3x2000_4x2000_5x2000_OMF2x4000_4x4000,
accessory 12401109:

