

OSF 4x3000 SM

FibreDrain® oljerøyk oppsamler for kontinuerlig drift





Nederman OSF oljerøykeliminatør er utformet for å håndtere store mengder oljerøyk under kontinuerlig drift. De er utviklet med fokus på høy effektiv filtrering med lave vedlikeholdskostnader. Nederman OSF 4x3000 SM har som standard tre filternivåer der de to første nivåene består av filterkassetter med FibreDrain®-teknologi. Det tredje nivået består av et HEPA-filte i filterklassen H13 med en virkningsgrad på 99,95 % for MPPS iht. EN1822. Alle Nederman OSF-enhetene er klargjort for bruk av pre-filte.

- Tre filternivåer, valgfritt forfilter
- Målere for lesing av trykkfall ved hvert filtertrinn
- Drain: 4 off 1 1/2"
- Non-vibration fan suspension system

Produktnavn	OSF 4x3000 SM
Standard	2009/125/EC
Volum (for frakt) (m ³)	25
Støynivå (dB(A))	< 70 dB(A) @1,5 m fra serviceside med ekstra lyddempet viftehus og lyddemper
Beskyttelsesklasse:	IP55
Filtereffektivitet (%)	99,95
Installasjon	Innendørs
Materiale	Metallplater malt både innvendig og utvendig
Rengjøringsmetode, filter	Automatisk filter rens
Arbeidstrykk (kPa)	Max 4600 Pa
Kapasitet (maks. luftstrøm m ³ /t)	12000
Driftstemperatur	60°C (begrænset af filter)
Spenning (V)	400/690
Frekvens Hz	50
Antall faser	3
Antall filterelementer	30
Strømstyrke (A)	26/15,1
Farge	NCS-S 1005 B20G
Vekt (kg)	2800
Kraft (kW)	15
Avklaring av teknisk informasjon	Plus ti filter element som option









OSF 4x3000 SM

Bilde	Navn på datablad	Model
	OSF 4x3000, Innløpsflens 560x560mm venstre. Utløp 4 x 1 1/2" Hun.	12401149*
	OSF 4x3000, Innløpsflens 560x560mm høyre. Utløp 4 x 1 1/2" Hun.	12401150*

*Plus ti filter element som option

OSF 4x3000 SM

Tilbehør		Artikkelnummer
	Avløpspumpeboks, 50 Hz	12400054*
	Drain container with piping	12400764**
	Forfilter ORF 610x610x96	12400039
	Filter 1 olje (OSF1000,2000,3000)	12400006
	Filter 2 olje (OSF1000,2000,3000)	12400007
	HEPA-filter	12400012
	Inlet adapter OSF 4x3000, OMF 3x4000, OMF 2x6000	12401163
	Extension structure OSF 4x3000	12401168
	Fan enclosure 3 filters in depth	12401160
	Silencer 90° Ø 630 mm	12401159
	Drain pump box, 50 Hz, 10 litre/min at 10m, including controller	12401330
	OSF/OMF Instruction manual for mounting system for electric components	12401342
	OMF/OSF/MQL mounting system for electrical components	12401341

*Drain connection must be elevated min 200 mm from pump box support level

**Drain connection must be elevated min 420mm from container support level

OSF 4x3000 SM

OSF 4x3000 assembly of options:



OSF 4x3000 SM

OSF 4x3000 complete with options:

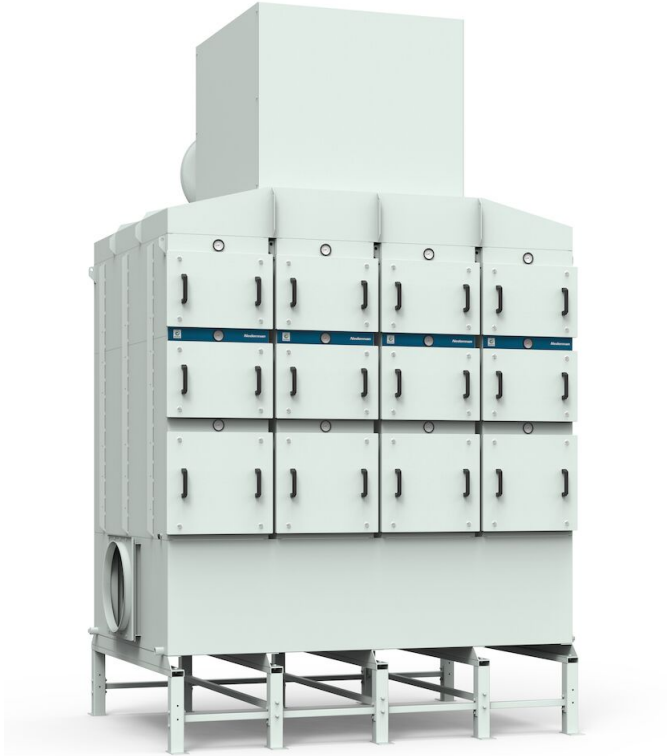

OSF 4x3000 SM

OSF 4x3000 with inlet from left side:

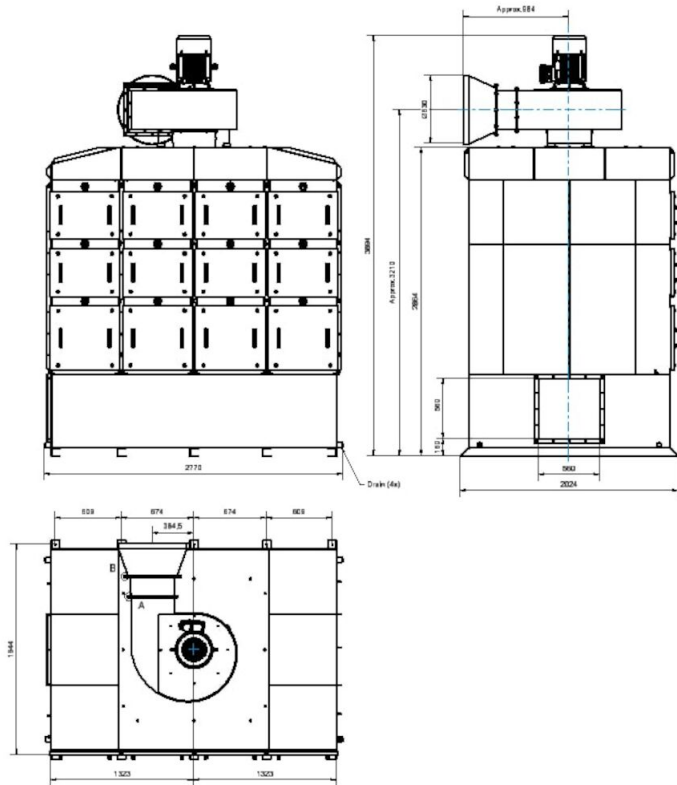

OSF 4x3000 SM

OSF 4x3000 with inlet from right side:

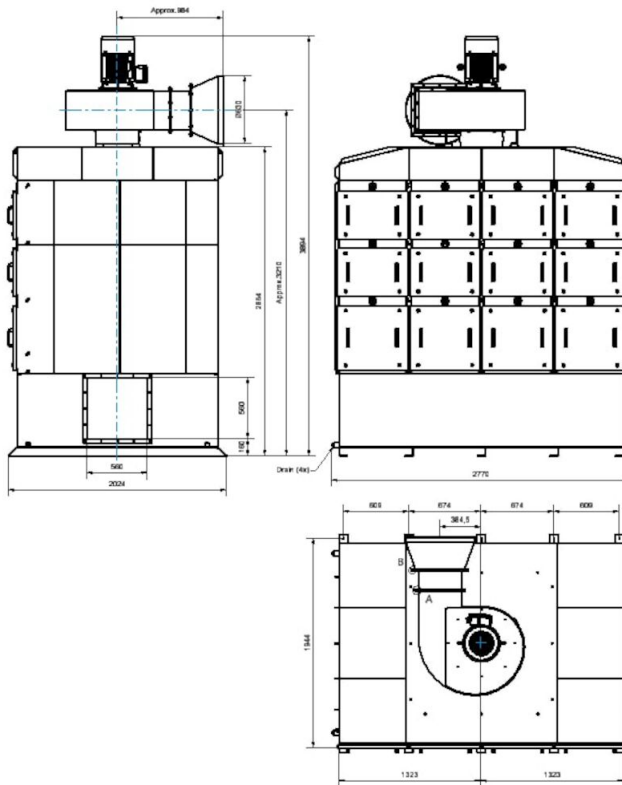

OSF 4x3000 SM

Dimension Inlet Adapter OSF4x3000_OMF3x4000_2x6000,
accessory 12401163:

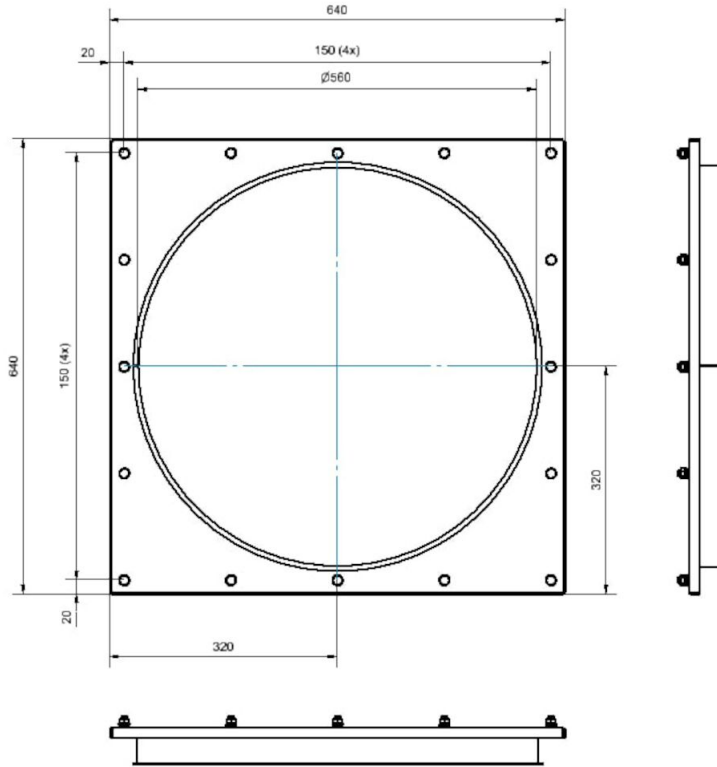

Dimension Extension Structure OSF4x3000,
accessory 12401168:

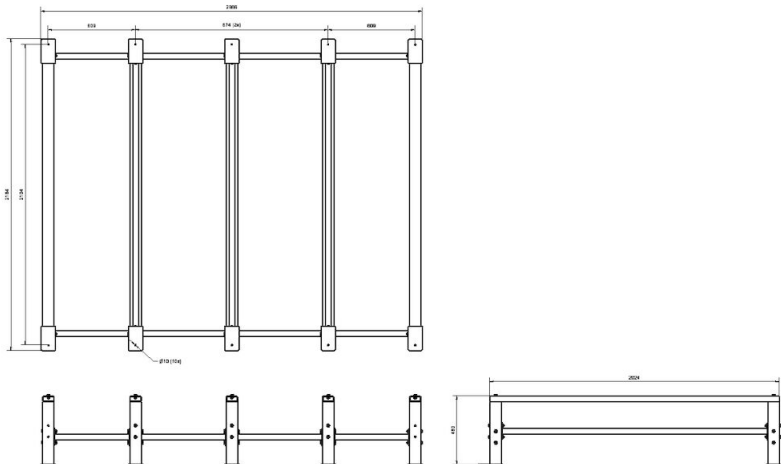

OSF 4x3000 SM

Dimension Fan Enclosure OSF4x3000_OMF2x6000,
accessory 12401160:

