

OSF 4x3000 SM

FibreDrain® olierook afzuiging voor continue operatie



Nederman OSF olienevelfilters zijn ontworpen om grote hoeveelheden olienevel en oliemist te filteren tijdens continue processen. De filters zijn ontwikkeld met focus op hoge efficiënte filtratie gecombineerd met lage onderhoudskosten.



Nederman OSF 4x3000 SM heeft standaard een 3 traps filtersysteem waarbij de eerste 2 trappen bestaan uit filtercassettes met Nederman FibreDrain® technologie. Nederman heeft een breed scala aan diverse types voor vele applicaties. De 3e trap van filtering bestaat uit een HEPA filter met klasse H13 met een efficiëntie van 99,95% voor MPPS volgens de EN1822. Alle modulaire Nederman filters zijn geschikt voor gebruik van een voorfilter. De OSF 4x3000 SM heeft een geïntegreerde ventilator.

- Drie filter trappen, optioneel voorfilter
- Meters voor aflezen van drukverlies over elke filter trap
- Drain: 4 off 1 1/2"
- Non-vibration fan suspension system

Product naam	OSF 4x3000 SM
Standaard	2009/125/EC
Volume (transport) (m ³)	25
Geluidsniveau (db(A))	< 70 dB(A) @1,5 m from service side with optional fan enclosure and silencer
Beschermingsklasse	IP55
Filter efficiëntie (%)	99,95
Installatie	Binnen
Materiaal	Plaatstaal, gespoten inwendig en uitwendig
Filter reinigingsmethode	[Draining]
Werkdruk (kPa)	Max 4600 Pa
Capaciteit (max. luchtstroom m ³ per uur)	12000
Temperatuurbereik	60° C (geïntegreerde ventilator)
Voltage (V)	400/690
Frequentie (Hz)	50
Aantal fase	3
Aantal filterelementen	30
Amperage (A)	26/15,1
Kleur	NCS-S 1005 B20G
Gewicht (kg)	2800
Vermogen (kW)	15
Toelichting van technische gegevens	Plus 10 optionele filter elementen.







OSF 4x3000 SM

Afbeelding	Naam voor Datasheet	Model
	OSF 4x3000, Inlaatflens 560x560mm links. Drain 4 x 1 ½" Vrouwelijk.	12401149*
	OSF 4x3000, Inlaatflens 560x560mm rechts. Drain 4 x 1 ½" Vrouwelijk.	12401150*

*Plus 10 optionele filter elementen.

OSF 4x3000 SM

Toebehoren		Artikelnummer
	Drain pump box, 50 Hz, 10 litre/min at 5m, including controller	12400054*
	Drain container with piping	12400764**
	Optional FibreDrain Pre Filter ORF 610x610x96 mm.	12400039
	FibreDrain Filter 1 OSF; 600x600x292 mm	12400006
	FibreDrain Filter 2 OSF; 600x600x292 mm	12400007
	HEPA DCM H13 610x610x292 mm	12400012
	Inlet adapter OSF 4x3000, OMF 3x4000, OMF 2x6000	12401163
	Extension structure OSF 4x3000	12401168
	Fan enclosure 3 filters in depth	12401160
	Silencer 90° Ø 630 mm	12401159
	Drain pump box, 50 Hz, 10 litre/min at 10m, including controller	12401330
	OSF/OMF Instruction manual for mounting system for electric components	12401342
	OMF/OSF/MQL mounting system for electrical components	12401341

*Drain connection must be elevated min 200 mm from pump box support level

**Drain connection must be elevated min 420mm from container support level

OSF 4x3000 SM

OSF 4x3000 assembly of options:



OSF 4x3000 SM

OSF 4x3000 complete with options:



OSF 4x3000 SM

OSF 4x3000 with inlet from left side:

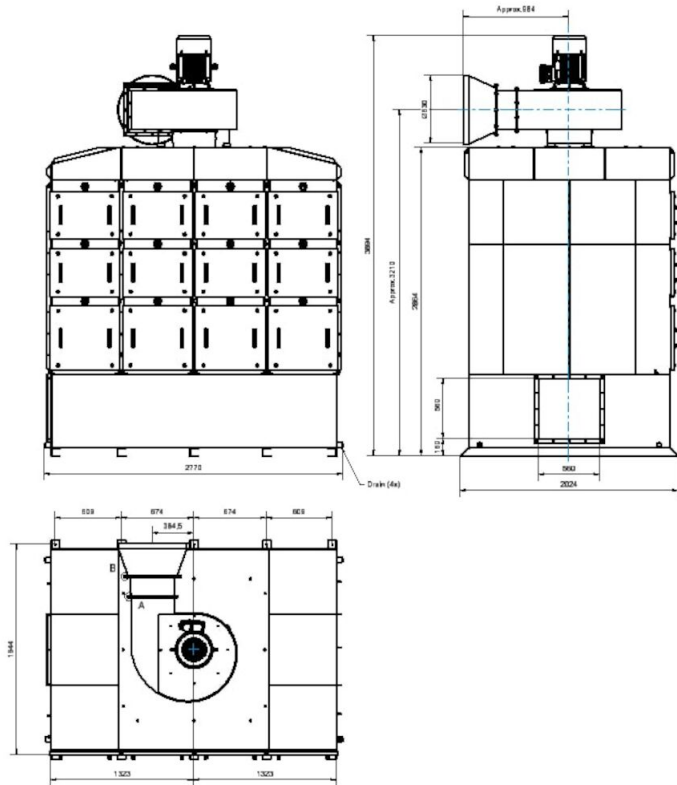

OSF 4x3000 SM

OSF 4x3000 with inlet from right side:

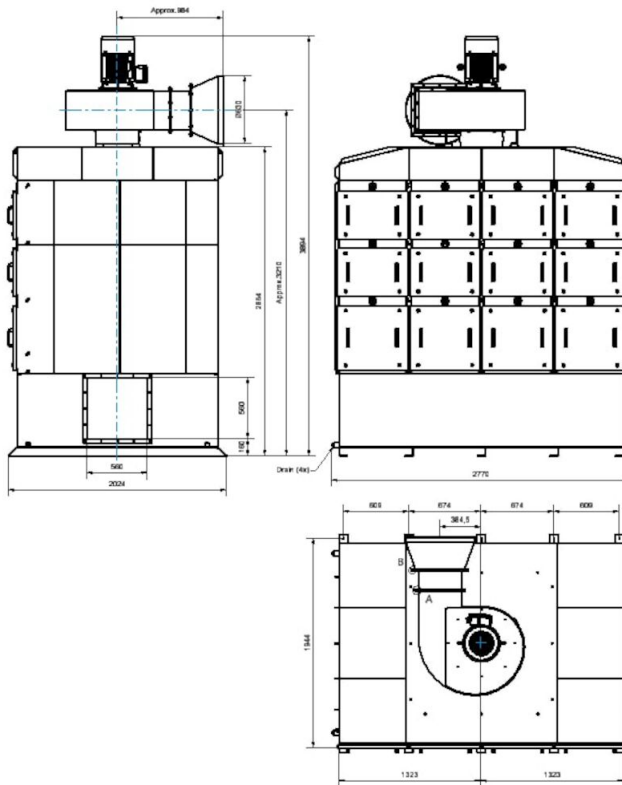

OSF 4x3000 SM

Dimension Inlet Adapter OSF4x3000_OMF3x4000_2x6000,
accessory 12401163:

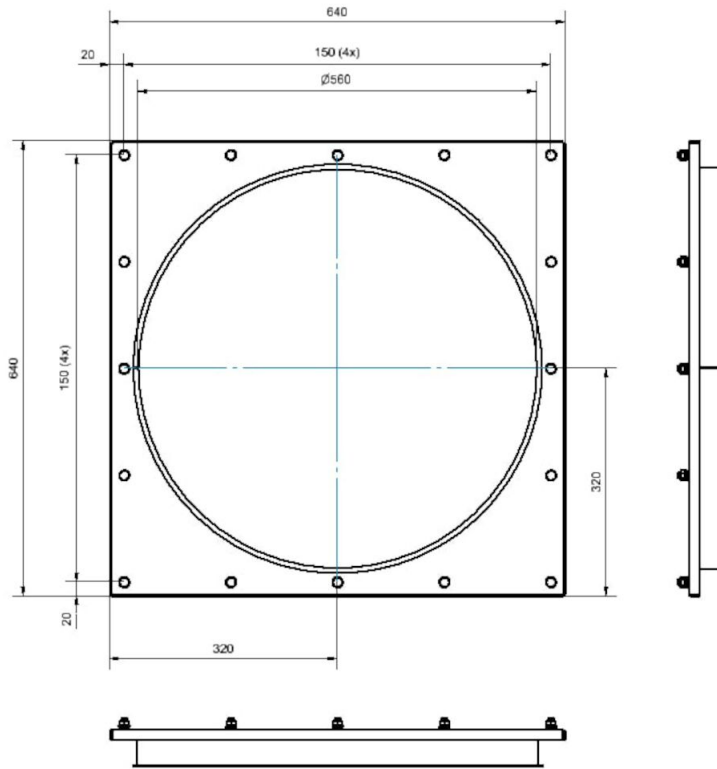

Dimension Extension Structure OSF4x3000,
accessory 12401168:

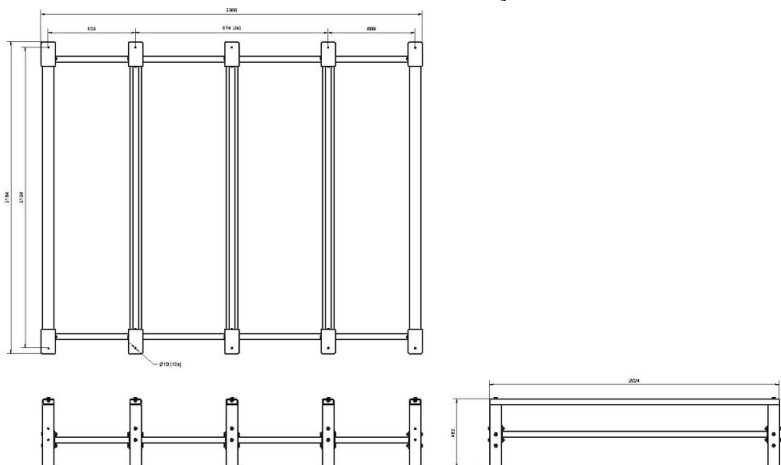

OSF 4x3000 SM

Dimension Fan Enclosure OSF4x3000_OMF2x6000,
accessory 12401160:

