

Udsugningsarm FX32 ESD

Fleksibel udsugningsarm for bordsarbejdspladser

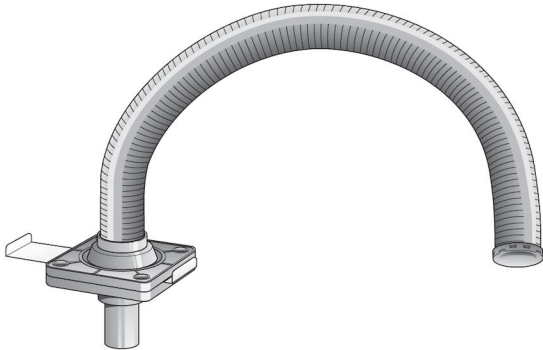

Udsugningsarme til brug i industrier, laboratorier, skoler etc. Fleksible plastik slanger med høj modstandsevne mod opløsningsmidler. Forbliver i den fastsatte position. ESD sikker. Kan drejes 360°. Dette betyder at rørsystemet forbliver stabilt og ikke roterer med armen. Monteres direkte på bordarbejdspladser eller med tilhørende montagebeslag. Kan monteres stående eller hængende.





Produkt navn	Udsugningsarm FX32 ESD
Lydniveau (dB(A))	48
Installation	Indendørs
Punktudsugningsdiameter (mm)	32
Luft volumen (m ³ /h)	20-45
Armlængde (m)	0,85



Udsugningsarm FX32 ESD

Beskrivelse	Model
FX 32 extraction arm ESD	70502934

Udsugningsarm FX32 ESD

Tilbehør		Artikelnummer
	Kuppel sugehoved 1/2 for FX 32 ESD	70371807
	Kuppel sugehoved 1/1 for FX 32 ESD	70371808
	Bordbeslag FX 32/50/75	70371761
	Vægbeslag FX 32	70371760

Udsugningsarm FX32 ESD

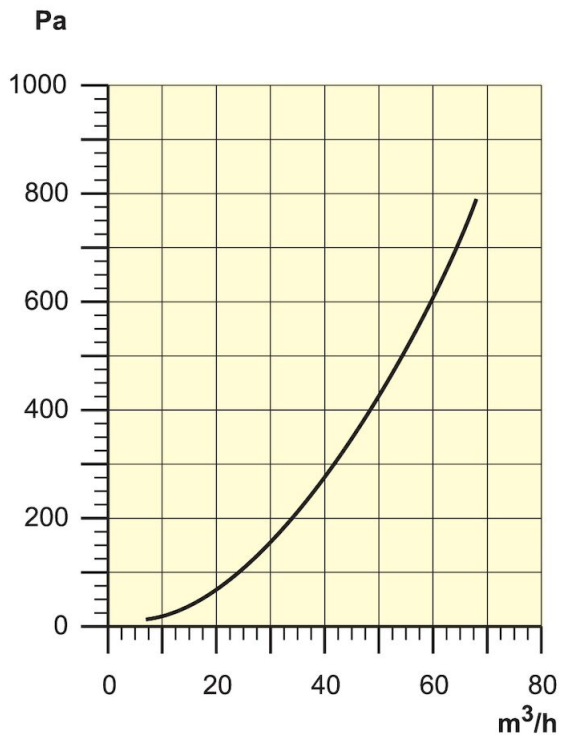

Pressure Drop

Udsugningsarm FX32 ESD

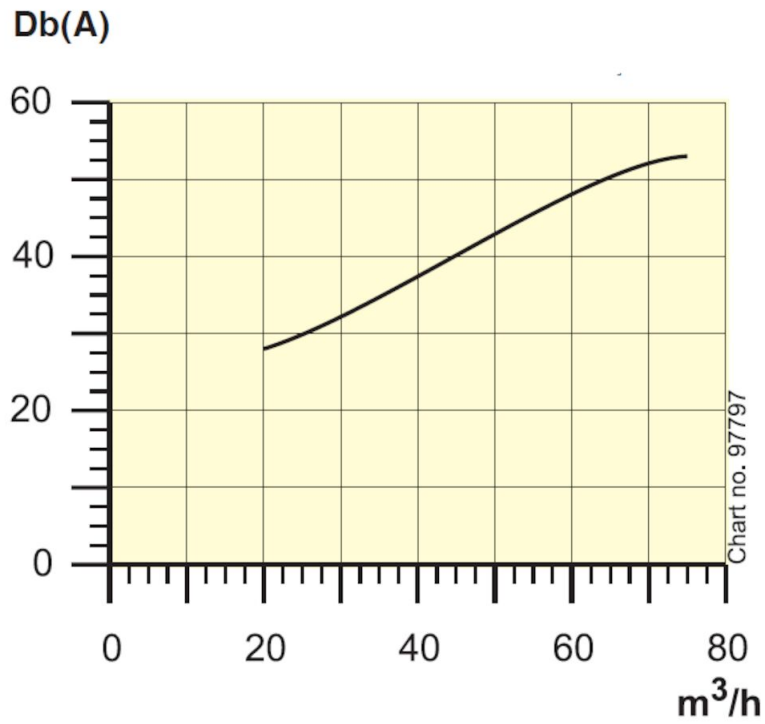

Sound Level
Distance to measuring point = 1m

Udsugningsarm FX32 ESD

