

Bench Top afzuigarm FX32 ESD

Flexibele Bench Top afzuigarm

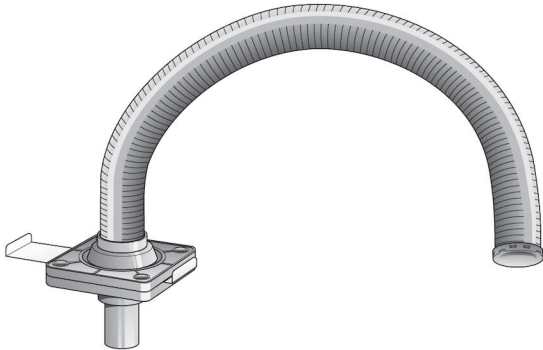

Afzuigarmen voor gebruik in de electronica industrie, laboratoria, scholen etc. Flexibele kunststof slang met een zeer goede bestendigheid tegen oplosmiddelen. Blijft in positie na aanpassing. ESD veilig. Voorzien van draaisteun, welke 360° kan draaien. Dit betekent dat de arm ten opzichte van het leidingwerk 360° kan draaien. Montage direct op het werkblad of met behulp van beugel aan de muur. Kan zowel staand als hangend gemonteerd worden.





Product naam	Bench Top afzuigarm FX32 ESD
Geluidsniveau (db(A))	48
Installatie	Binnen
Diameter afzuigslang (mm)	32
Luchtstroom (m ³ /per uur)	20-45
Arm lengte (m)	0,85



Bench Top afzuigarm FX32 ESD

Naam voor Datasheet	Model
FX 32 extraction arm ESD	70502934

Bench Top afzuigarm FX32 ESD

Toebehoren		Artikelnummer
	Dome hood 1/2 for FX 32 ESD	70371807
	Dome hood 1/1 for FX 32 ESD	70371808
	Table bracket, 75/50/32 Std/ESD/PP	70371761
	Wall bracket FX 32 Std/ESD/PP	70371760

Bench Top afzuigarm FX32 ESD

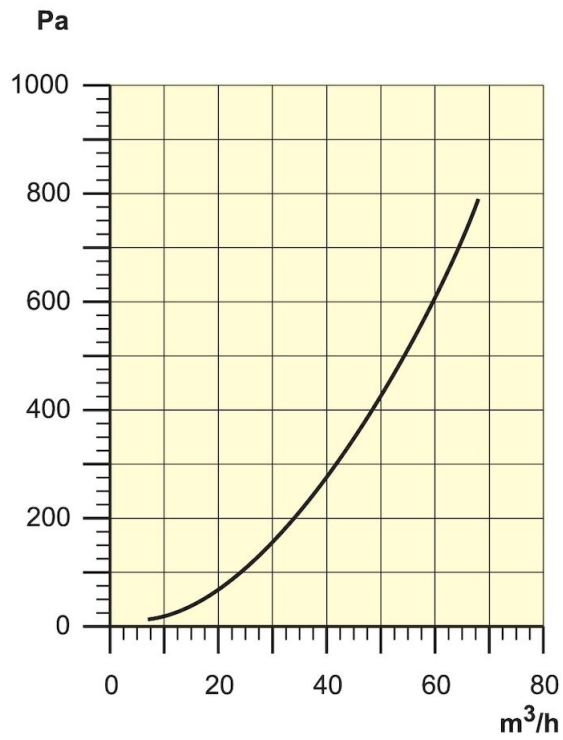

Pressure Drop

Bench Top afzuigarm FX32 ESD

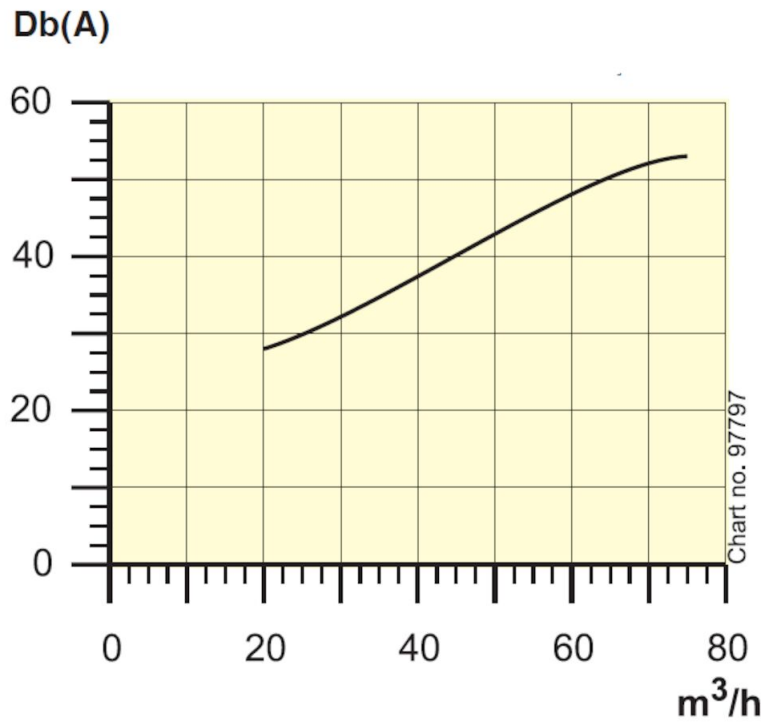

Sound Level
Distance to measuring point = 1m

Bench Top afzuigarm FX32 ESD

