

## MCP SmartFilter (FMC)

Mehrzweck-Patronenfilter für Innen- und Außeninstallationen kann für viele verschiedene Industriezweige wie Metallverarbeitung, Lebensmittel und Pharmazie, Chemie, Mineralien, Recycling, Verbundwerkstoffe, Holz und andere stauberzeugende Industrien verwendet werden.

---

## MCP SmartFilter (FMC)



MCP SmartFilter ist ein Mehrzweck-Filtrationssystem. Es kann an die kundenspezifischen Anforderungen angepasst werden, um einen Luftstrom von bis zu 28 000 m<sup>3</sup>/h in einzelnen Einheiten zu erzielen. Es eignet sich für Rauch und Staub und kann in verschiedenen Anwendungen wie Schweißen, Metallschneiden und allgemeinem Staub eingesetzt werden.

Das modulare Design ermöglicht sowohl Einzelplatzlösungen als auch Multifilterlösungen für erweiterte Anforderungen. Mit einem neuen und innovativen Patronendesign - die Kreisform nutzt den quadratischen Raum innerhalb des Staubsammlers optimal aus und erzeugt einen hohen Patronenluftstrom. Dadurch wird die Größe und damit die Grundfläche des Systems verringert.

Die Konstruktion aus 2 mm verzinkten Stahlpaneelen ermöglicht eine einfache Installation, einen kostengünstigen Versand und bietet Korrosionsschutz. Das Design ist auf eine lange Filterlebensdauer optimiert und bietet niedrige Betriebskosten.

Die Insight-Ready-Steuerung mit fortschrittlicher Impulsreinigungslogik sorgt für einen vollständigen Systembetrieb einschließlich Steuerung und Überwachung sowie Gateway-Funktionalität für die Cloud-Kommunikation.

Der MCP SmartFilter verfügt über ein umfangreiches Zubehörprogramm, darunter Ventilatoren, Sensoren, Einlässe, Behälter usw., und die Patronen sind in einer Vielzahl von Materialien erhältlich.

- Gewinnen Sie mit Insight Analytics die Kontrolle über die Filterleistung. Nederman's einzigartige Überwachungstechnologie
- Optimierte Stellfläche durch innovatives Patronendesign mit hohem Luftdurchsatz
- Reduzierte Gesamtkosten durch intelligentes Reinigungssystem, lange Filterpatronen-Lebensdauer und optimierte Stellfläche
- Fortschrittliche Steuerung, die für IoT-Anwendungen vorbereitet ist - Insight Ready
- Controller, HMI und Gateway in einer Einheit mit dem Insight Control Panel.









Produktname	MCP SmartFilter (FMC)
Druckluftverbrauch	60 Liter pro Reinigungsimpuls

## MCP SmartFilter (FMC)

	bei 6,0 bar Druckluft
Installation	im Gebäude, im Freien
Material	Verzinkter Stahl
Geeignet für explosionsfähigen Staub	False
Filterreinigungsmethode	Impulsstrahl
Applikation	Rauche, Stäube
Max. Arbeitsdruck (kPa)	Unterdruck max. 6 kPa. Überdruck max. 0 Pa. (1,5 kPa für Silotop-Lösung)
Volumen Staubbehälter (l)	50 oder 100 Liter Behälter
Filterfläche (m <sup>2</sup> )	Polyester: 30 bis 192 m <sup>2</sup> SC178: 67 bis 422 m <sup>2</sup> Polyester: 30 bis 192 m <sup>2</sup> SC178: 67 bis 422 m <sup>2</sup> Polyester: 30 bis 192 m <sup>2</sup> SC178: 67 bis 422 m <sup>2</sup> SC179: 32 bis 208 m <sup>2</sup>
Kapazität (Max Volumenstrom m <sup>3</sup> /h)	4500 bis 28000
Betriebstemperatur	-20 bis +70 Grad C.
Filtertyp	Patronenfilter
Filtermaterial	Je nach Anwendung
Farbe	



## MCP SmartFilter (FMC)

Bild	Beschreibung	Anzahl der Filter	Modell
	MCP-2-BS SmartFilter	8	MCP-2-BS*
	MCP-4-16S SmartFilter	16	MCP-4-16S
	MCP-6-24S SmartFilter	24	MCP-6-24S
	MCP-8-32S SmartFilter	32	MCP-8-32S
	MCP-2-BSL SmartFilter	8	MCP-2-BSL
	MCP-4-16SL SmartFilter	16	MCP-4-16SL
	MCP-6-24SL SmartFilter	24	MCP-6-24SL
	MCP-8-32SL SmartFilter	32	MCP-8-32SL

\*Configured product

## MCP SmartFilter (FMC)

### Cartridge material

- SC100 – Spunbond polyester
- SC140 – Spunbond polyester with antistatic treatment
- SC141 – Spunbond polyester with antistatic treatment and PTFE coating
- SC150 – Spunbond polyester with ePTFE membrane
- SC151 – Spunbond polyester with antistatic treatment and ePTFE membrane
- SC178/SC179 – 80% cellulose, 20% polyester material with nanofiber
- SC190 – Spunbond polyester with PTFE coating

### A – Height of Clean Air Chamber (mm)

200	350	500	650
Shown in drawings	Add 150 mm in height	Add 300 mm in height	Add 450 mm in height







### Filter area

Filter type	Quantity of cartridges	Filter area (m <sup>2</sup> )			Max. airflow (m <sup>3</sup> /h)*
		SC100, SC140, SC141, SC150, SC151, SC190	SC178	SC179	
MCP-2-8S MCP-2-8S-Ex	8	48,0	105,6	52,0	7000
MCP-4-16S MCP-4-16S-Ex	16	96,0	211,2	104,0	14000
MCP-6-24S MCP-6-24S-Ex	24	144,0	316,8	156,0	21000
MCP-8-32S MCP-8-32S-Ex	32	192,0	422,4	208,0	28000
MCP-2-8SL MCP-2-8SL-Ex	8	30,4	67,2	32,8	4500
MCP-4-16SL MCP-4-16SL-Ex	16	60,8	134,4	65,6	9000
MCP-6-24SL MCP-6-24SL-Ex	24	91,2	201,6	98,4	13500
MCP-8-32SL MCP-8-32SL-Ex	32	121,6	268,8	131,2	18000

\*Max. air flow is dependent on the dust type, etc.

## MCP SmartFilter (FMC)

### Accessories

Figure	Description	Figure	Description
	Top mounted FM-fans 50 Hz or 60 Hz up to 14000 m <sup>3</sup> /h		Leg height extensions from 0 mm to 2000 mm to fit larger bins/containers, rotary valves and big bags
	Combifab remote fans 50 Hz or 60 Hz		Leg width extension 300 mm to left, right or both sides to fit larger bins/containers, rotary valves and big bags
	Noise enclosure to reduce fan and motor break-out-noise of FM-fans		Suspension below rotary valve for big bag
	Dual silencer to reduce air flow, fan noise and motor break-out-noise of FM-fans (available with grid (indoor use), grid and rain cover (outdoor use) or flange for duct connection)		Isolation box for pressure tank incl. clearing valves
	Regulation (iris) damper at fan inlet for FM-fans		Access platform with ladder for maintenance
	Dust bins (50 l, 50 l with wheels and 100 l with wheels)		Lime feeder NFKG-70
	Plastic bag in the dust bin with pressure compensation set 'bin balancing'		Several sensors available for extraction, filtration and discharge process
	Rotary valves NRS3 and NRSZ3		Water separator and pressure regulator
	Dust discharge valve NFUS3		QF-duct system

## MCP SmartFilter (FMC)

MCP-2-8S / MCP-2-8S-Ex  
MCP-2-8SL / MCP-2-8SL-Ex

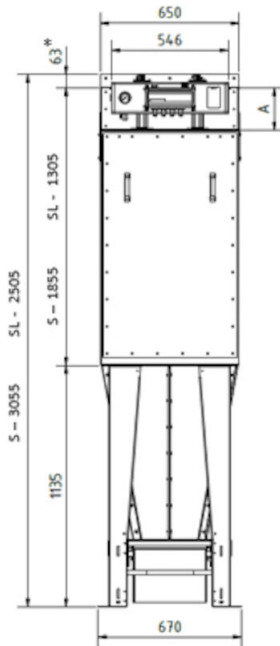

All dimensions in mm.

If 50 liter bin with wheels 90 mm must be added to the height.

\* to be included only if a top mounted FM fan is used (transition for fan).

## MCP SmartFilter (FMC)

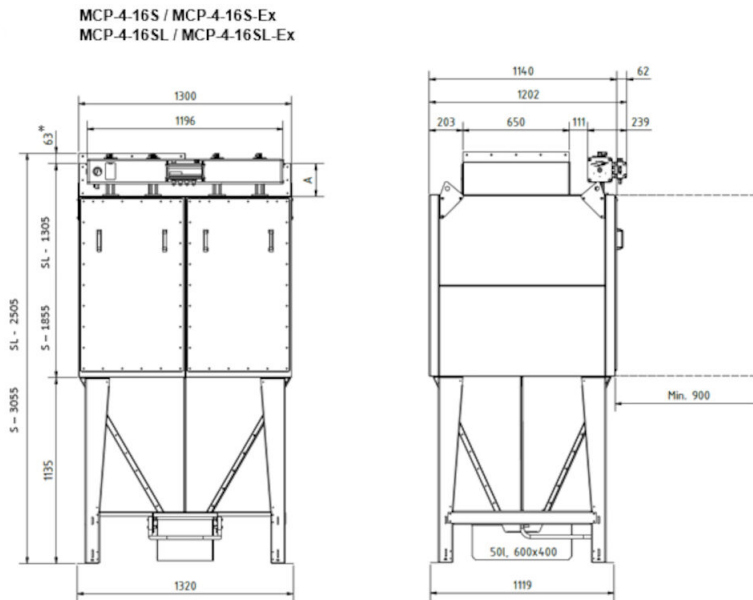

All dimensions in mm.

If 50 liter bin with wheels 90 mm must be added to the height.

\* to be included only if a top mounted FM fan is used (transition for fan).



## MCP SmartFilter (FMC)

MCP-6-24S / MCP-6-24S-Ex  
MCP-6-24SL / MCP-6-24SL-Ex

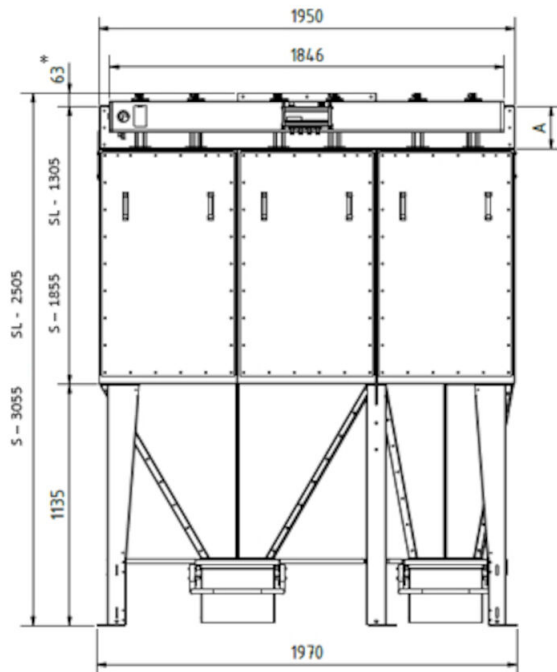

All dimensions in mm.

If 50 liter bin with wheels 90 mm must be added to the height.

\* to be included only if a top mounted FM fan is used (transition for fan).

## MCP SmartFilter (FMC)

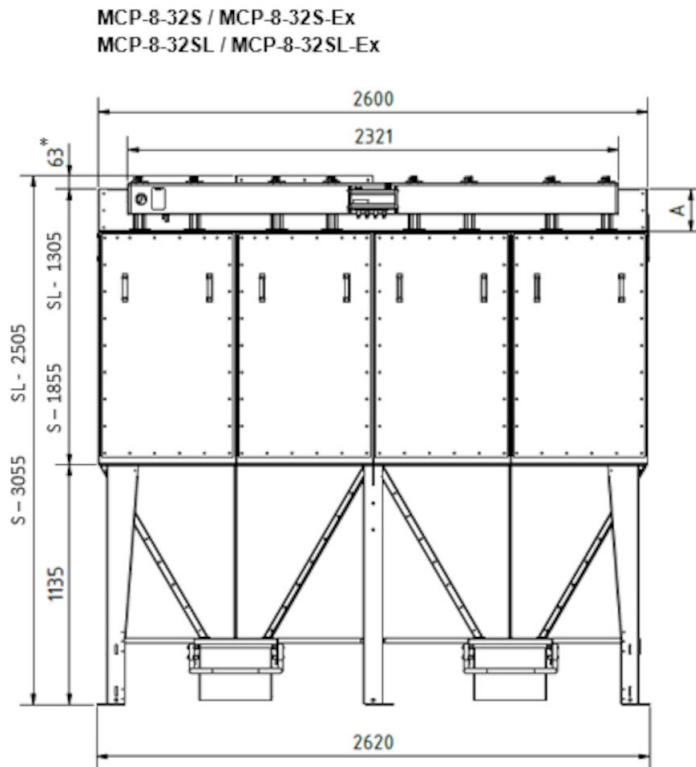

All dimensions in mm.

If 50 liter bin with wheels 90 mm must be added to the height.

\* to be included only if a top mounted FM fan is used (transition for fan).