

## MCP Smartfilter

Multifunktionellt patronfilter för både inom och utomhus-installation. MCP Smartfilter är lämplig för många olika "dammproducerande" industrier

---

## MCP Smartfilter



MCP Smartfilter är ett multifunktionellt filteringsystem. Det är anpassningsbart för luftflöden upp till 28.000 m<sup>3</sup>/h. MCP Smartfilter är lämplig för rök, damm och brännbart damm och kan användas i flera olika tillämpningar såsom t ex. svetsning, metallskärning och allmänt damm.

Den modulära konstruktionen möjliggör fristående lösningar likaväl som multifunktionslösningar för utökade krav. Med en ny och innovativ filterpatronkonstruktion "Squirle shape" kombineras patronfiltrets bascirkelsform med kvadratiska inslag. Denna konstruktion möjliggör större filtreringsflöden genom filterkassetten och därmed kan man minska själva filterenhetens storlek vilket leder till mindre platskrävande installationer.

Enheten är konstruerad med 2 mm galvaniserade stålpaneler och är enkelt att installera, kostnadseffektivt att skicka och har ett korrosionsskydd. Konstruktionen är optimerad för lång filterlivslängd vilket ger låga produktivslängdskostnader.

"Insight ready" med avancerad pulsrengöringslogik ger full systemdrift inklusive styrning och övervakning samt gatewayfunktioner för molnkommunikation.

MCP SmartFilter har ett stort tillbehörsprogram inklusive; fläktar, inlopp, behållare för bortfiltrerat material etc. och med en variation filterpatronerna beroende av vad som filtreras.

- Få kontroll över filtreringsprocessen med Insight Analytics. Nedermans unika övervakningsteknik
- Optimerad "footprint" tack vare innovativ filterpatrondesign med högt luftflöde.
- Reducerad totalkostnad tack vare intelligent rensningssystem och lång livslängd på filterpatroner.
- Framtidsförberedd filtersystem som är IoT anpassat - Insight Ready
- Controller, HMI and Gateway all in one unit with the Insight Control Panel.

Produkt namn	MCP Smartfilter
Tryckluftsförbrukning	60 liter per rengöringspuls vid 6,0 bar tryckluft
Installation	Inomhus, Utomhus
Material	2 mm galvaniserad plåt
Lämplig för explosivt damm	False
Metod för filterrensning	Puls jet
Applikation	Rök, Stoft
Arbetsstryck (kPa)	Max vakuum: 6KPa Max övertryck: 0 Pa (1,5 KPa för silotoplösning)
Volym stoftbehållare (l)	50 eller 100 liters behållare
Filterarea (m <sup>2</sup> )	Polyester: 30 to 192 m <sup>2</sup>

## MCP Smartfilter

	SC178: 67 to 422 m <sup>2</sup> SC179: 32 to 208 m <sup>2</sup>
Kapacitet (max luftflöde m <sup>3</sup> /h)	4500 till 28000
Temperaturområde	-20°C till +70°C.
Typ av filter	Patron
Filtermaterial	Beroende på applikation
Färg	
Observera	Konfigurerad produkt











Rök



Stoft



## MCP Smartfilter

Bild	Beskrivning	Antal filter	Model
	MCP-2-8S SmartFilter	8	MCP-2-8S*
	MCP-4-16S SmartFilter	16	MCP-4-16S*
	MCP-6-24S SmartFilter	24	MCP-6-24S*
	MCP-8-32S SmartFilter	32	MCP-8-32S*
	MCP-2-8SL SmartFilter	8	MCP-2-8SL*
	MCP-4-16SL SmartFilter	16	MCP-4-16SL*
	MCP-6-24SL SmartFilter	24	MCP-6-24SL*
	MCP-8-32SL SmartFilter	32	MCP-8-32SL*

\*Konfigurerad produkt

## MCP Smartfilter

### Cartridge material

- SC100 – Spunbond polyester
- SC140 – Spunbond polyester with antistatic treatment
- SC141 – Spunbond polyester with antistatic treatment and PTFE coating
- SC150 – Spunbond polyester with ePTFE membrane
- SC151 – Spunbond polyester with antistatic treatment and ePTFE membrane
- SC178/SC179 – 80% cellulose, 20% polyester material with nanofiber
- SC190 – Spunbond polyester with PTFE coating

### A – Height of Clean Air Chamber (mm)

200	350	500	650
Shown in drawings	Add 150 mm in height	Add 300 mm in height	Add 450 mm in height









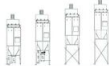

### Filter area

Filter type	Quantity of cartridges	Filter area (m <sup>2</sup> )			Max. airflow (m <sup>3</sup> /h)*
		SC100, SC140, SC141, SC150, SC151, SC190	SC178	SC179	
MCP-2-8S MCP-2-8S-Ex	8	48,0	105,6	52,0	7000
MCP-4-16S MCP-4-16S-Ex	16	96,0	211,2	104,0	14000
MCP-6-24S MCP-6-24S-Ex	24	144,0	316,8	156,0	21000
MCP-8-32S MCP-8-32S-Ex	32	192,0	422,4	208,0	28000
MCP-2-8SL MCP-2-8SL-Ex	8	30,4	67,2	32,8	4500
MCP-4-16SL MCP-4-16SL-Ex	16	60,8	134,4	65,6	9000
MCP-6-24SL MCP-6-24SL-Ex	24	91,2	201,6	98,4	13500
MCP-8-32SL MCP-8-32SL-Ex	32	121,6	268,8	131,2	18000

\*Max. air flow is dependent on the dust type, etc.

## MCP Smartfilter

### Accessories

Figure	Description	Figure	Description
	Top mounted FM-fans 50 Hz or 60 Hz up to 14000 m <sup>3</sup> /h		Leg height extensions from 0 mm to 2000 mm to fit larger bins/containers, rotary valves and big bags
	Combifab remote fans 50 Hz or 60 Hz		Leg width extension 300 mm to left, right or both sides to fit larger bins/containers, rotary valves and big bags
	Noise enclosure to reduce fan and motor break-out-noise of FM-fans		Suspension below rotary valve for big bag
	Dual silencer to reduce air flow, fan noise and motor break-out-noise of FM-fans (available with grid (indoor use), grid and rain cover (outdoor use) or flange for duct connection)		Isolation box for pressure tank incl. clearing valves
	Regulation (iris) damper at fan inlet for FM-fans		Access platform with ladder for maintenance
	Dust bins (50 l, 50 l with wheels and 100 l with wheels)		Lime feeder NFKG-70
	Plastic bag in the dust bin with pressure compensation set 'bin balancing'		Several sensors available for extraction, filtration and discharge process
	Rotary valves NRS3 and NRSZ3		Water separator and pressure regulator
	Dust discharge valve NFUS3		QF-duct system

## MCP Smartfilter

MCP-2-8S / MCP-2-8S-Ex  
MCP-2-8SL / MCP-2-8SL-Ex

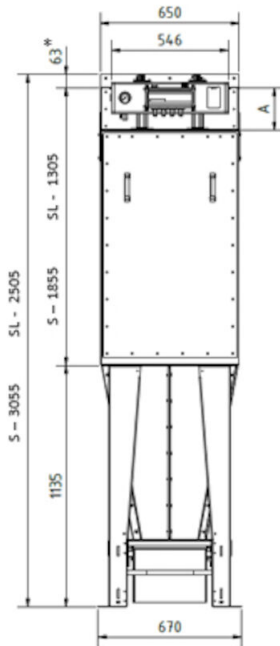

All dimensions in mm.

If 50 liter bin with wheels 90 mm must be added to the height.

\* to be included only if a top mounted FM fan is used (transition for fan).

## MCP Smartfilter

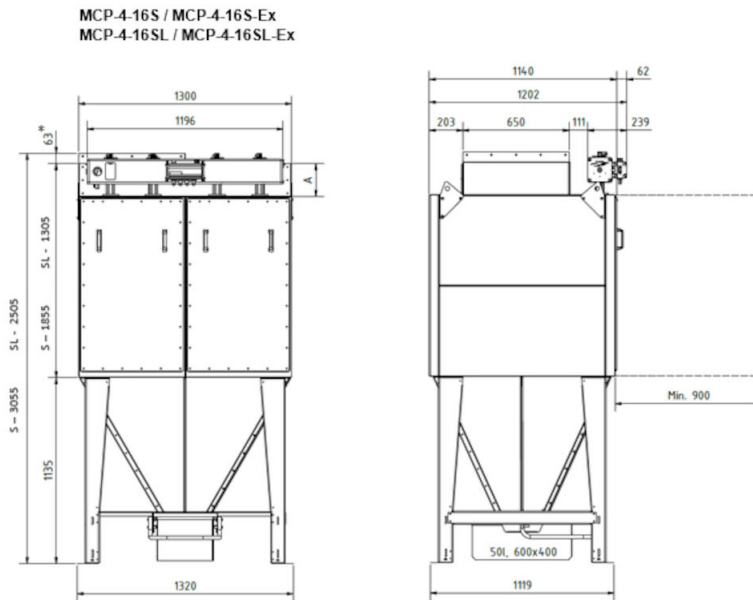

All dimensions in mm.

If 50 liter bin with wheels 90 mm must be added to the height.

\* to be included only if a top mounted FM fan is used (transition for fan).



## MCP Smartfilter

MCP-6-24S / MCP-6-24S-Ex  
MCP-6-24SL / MCP-6-24SL-Ex

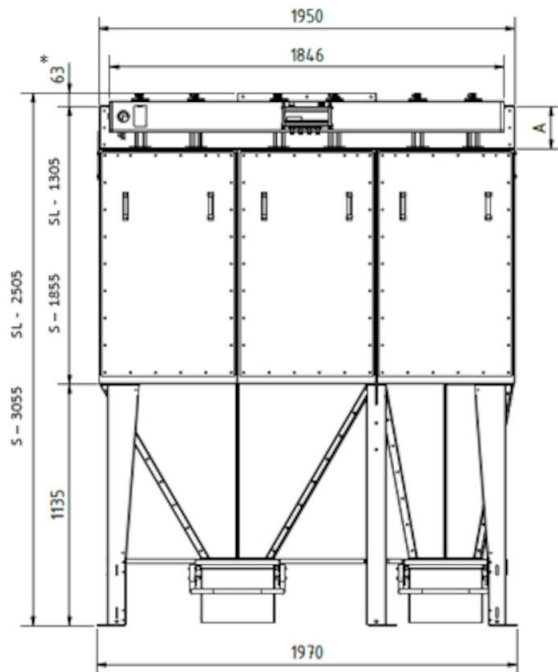

All dimensions in mm.

If 50 liter bin with wheels 90 mm must be added to the height.

\* to be included only if a top mounted FM fan is used (transition for fan).

## MCP Smartfilter

MCP-8-32S / MCP-8-32S-Ex  
MCP-8-32SL / MCP-8-32SL-Ex

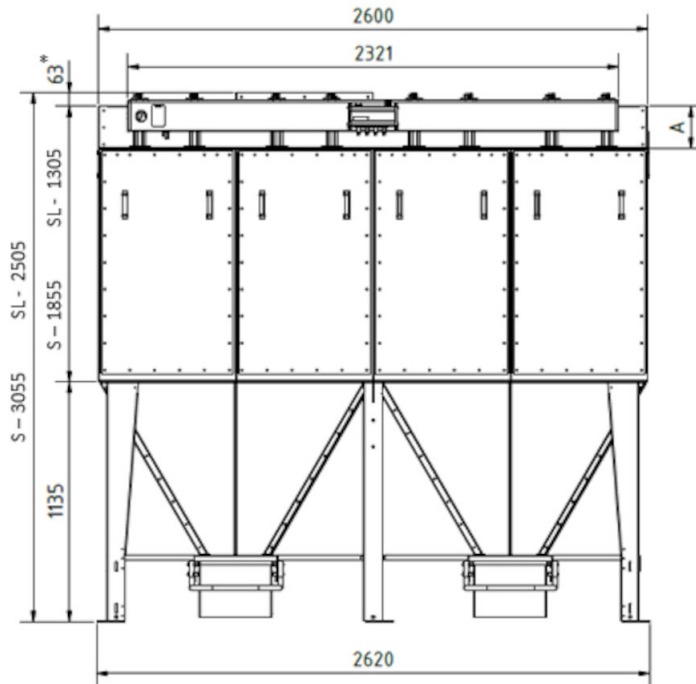

All dimensions in mm.

If 50 liter bin with wheels 90 mm must be added to the height.

\* to be included only if a top mounted FM fan is used (transition for fan).