

## MCP SmartFilter Ex

MCP SmartFilter Ex es un sistema de filtración polivalente, tanto para instalaciones interiores como exteriores. Adecuado para polvo inflamable, pudiendo utilizarse en una amplia variedad de sectores y aplicaciones industriales.

---

## MCP SmartFilter Ex



El MCP SmartFilter Ex es un sistema de filtración polivalente. Es configurable para adaptarse perfectamente a las demandas específicas de cada cliente, con caudales de aire de hasta 28 000 m<sup>3</sup> / h. Adecuado para polvo potencialmente inflamable, puede utilizarse en diferentes aplicaciones, como metales ligeros, materiales compuestos, compuestos orgánicos y polvo en general. Su diseño modular permite su uso instalación de forma individual o bien integrado en un sistema multi-filtro en aquellas aplicaciones que así lo requieran. Con el nuevo e innovador diseño "Squircle" (cuadrado con bordes redondeados) de los cartuchos filtrantes, hacemos que la forma cuadrada de su geometría optimice el espacio dentro del filtro, dotando al cartucho de una alta capacidad en cuanto a caudal de aire. De esta forma permite al filtro reducir de forma notable la huella que el sistema ocupa en planta.

Fabricado con paneles de acero galvanizado de 2 mm. es fácil de instalar, proporciona protección contra la corrosión y, por su configuración, reduce los costes de transporte. El diseño está optimizado para ofrecer una larga vida útil del filtro, y por tanto unos bajos costes de operación.

El sistema de control "Insight", que incluye un sistema de limpieza muy avanzado mediante una lógica de pulsos, dota a todo el sistema de un control y monitorización continuo, así como la funcionalidad de almacenamiento y acceso a la información en la nube de todos los datos recopilados en cuanto al comportamiento del sistema. Cumplimiento de las directivas y normativas vigentes a nivel global, especialmente en cuanto al cumplimiento de aquellas aplicaciones para polvo inflamable (ATEX). El filtro MCP SmartFilter Ex dispone de una gran gama de accesorios, que abarca desde aspiradores, diferentes tipos de entrada, contenedores de polvo, etc. Los cartuchos están disponibles en una amplia variedad de materiales filtrantes.

- Tome las riendas sobre el rendimiento del sistema de filtración con Insight Analytics. La tecnología de monitorización de Nederman
- Mínima huella en planta gracias al innovador diseño del cartucho con un alto caudal de aire admisible
- Reducido TCO (coste total de propiedad) gracias al sistema de limpieza inteligente, a la larga vida útil de los cartuchos filtrantes y a la optimización de la huella en planta.
- Adaptado a IoT. Preparado para el futuro con Insight Ready
- Controlador, HMI y gateway, todo en una unidad con el Panel de control Insight.

Nombre de producto	MCP SmartFilter Ex
Eficacia de filtración (%)	99,9
Consumo aire comprimido	60 litros por pulso de limpieza a 6,0 bar de aire comprimido

## MCP SmartFilter Ex









Instalación	Interior, Exterior
Material	Acero galvanizado
Apropiado para polvo combustible	True
Tipo de método de limpieza	Pulse jet
Application	Humo, Polvo
Presión de trabajo (kPa)	Vacío máx. 6 kPa. Sobrepresión máx. 0 Pa. (1,5 kPa para solución integrada sobre silo)
Capacidad del contenedor (l)	Contenedor de 50 o 100 litros
Superficie de filtración (m <sup>2</sup> )	Poliéster: 30 a 192 m <sup>2</sup> .
Capacidad (Máx. caudal m <sup>3</sup> /h)	4500 to 28000
Operating Temperature	` -20°C a +70°C
Tipo de filtro	Cartucho
Material filtrante	Dependiendo de la aplicación
Aclaraciones a la ficha técnica	



Humo

Polvo

## MCP SmartFilter Ex

Imagen	Nombre para ficha de datos	Número de elementos filtrantes	Moldelo
	MCP-2-8S-Ex SmartFilter	8	MCP-2-8S-Ex
	MCP-4-16S-Ex SmartFilter	16	MCP-4-16S-Ex
	MCP-6-24S-Ex SmartFilter	24	MCP-6-24S-Ex
	MCP-8-32S-Ex SmartFilter	32	MCP-8-32S-Ex
	MCP-2-8SL-Ex SmartFilter	8	MCP-2-8SL-Ex
	MCP-4-16SL-Ex SmartFilter	16	MCP-4-16SL-Ex
	MCP-6-24SL-Ex SmartFilter	24	MCP-6-24SL-Ex
	MCP-8-32SL-Ex SmartFilter	32	MCP-8-32SL-Ex

## MCP SmartFilter Ex

### Product Marking of MCP SmartFilter Ex

CE  II 1D/3D/- c Ex h III C 120°C Da/Dc/-

Product marking of MCP SmartFilter Ex

Pred,max	KST	Zone Placement
0,3 bar	St1 (0 to 200 bar m s <sup>-1</sup> ) St2 (> 200 to 300 bar m s <sup>-1</sup> ) St3 (> 300 bar m s <sup>-1</sup> )*	None-zone Zone 22*

\*Not available as standard, available by request

MCP SmartFilter Ex specifications

#### Cartridge material

- SC100 – Spunbond polyester
- SC140 – Spunbond polyester with antistatic treatment
- SC141 – Spunbond polyester with antistatic treatment and PTFE coating
- SC150 – Spunbond polyester with ePTFE membrane
- SC151 – Spunbond polyester with antistatic treatment and ePTFE membrane
- SC178/SC179 – 80% cellulose, 20% polyester material with nanofiber
- SC190 – Spunbond polyester with PTFE coating

#### A – Height of Clean Air Chamber (mm)

200	350	500	650
Shown in drawings	Add 150 mm in height	Add 300 mm in height	Add 450 mm in height



















## MCP SmartFilter Ex

### Filter area

Filter type	Quantity of cartridges	Filter area (m <sup>2</sup> )			Max. airflow (m <sup>3</sup> /h)*
		SC100, SC140, SC141, SC150, SC151, SC190	SC178	SC179	
MCP-2-8S MCP-2-8S-Ex	8	48,0	105,6	52,0	7000
MCP-4-16S MCP-4-16S-Ex	16	96,0	211,2	104,0	14000
MCP-6-24S MCP-6-24S-Ex	24	144,0	316,8	156,0	21000
MCP-8-32S MCP-8-32S-Ex	32	192,0	422,4	208,0	28000
MCP-2-8SL MCP-2-8SL-Ex	8	30,4	67,2	32,8	4500
MCP-4-16SL MCP-4-16SL-Ex	16	60,8	134,4	65,6	9000
MCP-6-24SL MCP-6-24SL-Ex	24	91,2	201,6	98,4	13500
MCP-8-32SL MCP-8-32SL-Ex	32	121,6	268,8	131,2	18000

\*Max. air flow is dependent on the dust type, etc.

### Accessories

Figure	Description	Figure	Description
	Top mounted FM-fans 50 Hz or 60 Hz up to 14000 m <sup>3</sup> /h		Leg height extensions from 0 mm to 2000 mm to fit larger bins/containers, rotary valves and big bags
	Combifab remote fans 50 Hz or 60 Hz		Leg width extension 300 mm to left, right or both sides to fit larger bins/containers, rotary valves and big bags
	Noise enclosure to reduce fan and motor break-out-noise of FM-fans		Suspension below rotary valve for big bag
	Dual silencer to reduce air flow, fan noise and motor break-out-noise of FM-fans (available with grid (indoor use), grid and rain cover (outdoor use) or flange for dust connection)		Isolation box for pressure tank incl. cleaning valves
	Regulation (iris) damper at fan inlet for FM-fans		Access platform with ladder for maintenance
	Dust bins (50 l, 50 l with wheels and 100 l with wheels)		Lime feeder NFKG-70
	Plastic bag in the dust bin with pressure compensation set 'bin balancing'		Several sensors available for extraction, filtration and discharge process
	Rotary valves NRS3 and NRSZ3		Water separator and pressure regulator
	Dust discharge valve NFUS3		QF-duct system

## MCP SmartFilter Ex

MCP-2-8S / MCP-2-8S-Ex  
MCP-2-8SL / MCP-2-8SL-Ex

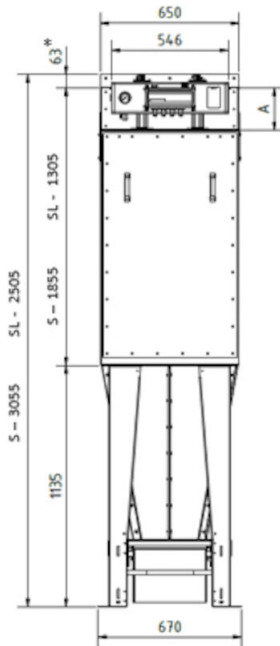

All dimensions in mm.

If 50 liter bin with wheels 90 mm must be added to the height.

\* to be included only if a top mounted FM fan is used (transition for fan).

## MCP SmartFilter Ex

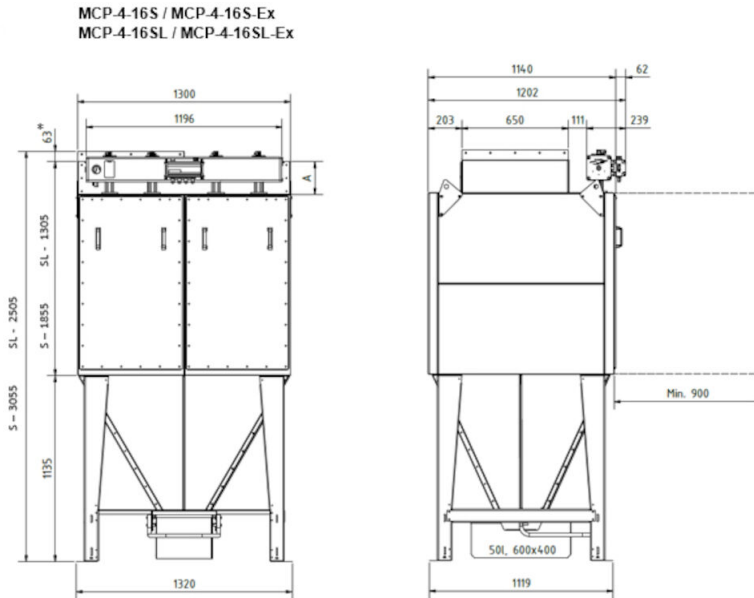

All dimensions in mm.

If 50 liter bin with wheels 90 mm must be added to the height.

\* to be included only if a top mounted FM fan is used (transition for fan).





## MCP SmartFilter Ex

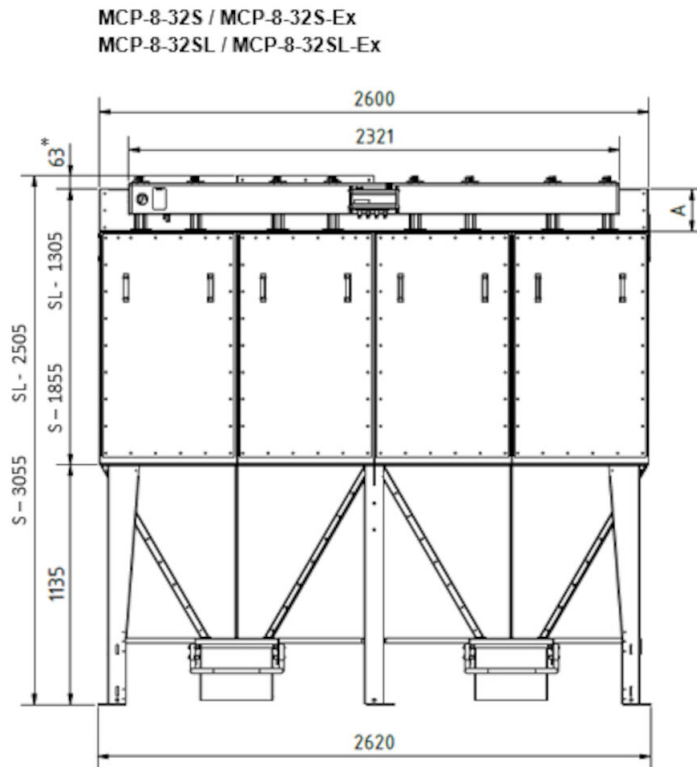

All dimensions in mm.

If 50 liter bin with wheels 90 mm must be added to the height.

\* to be included only if a top mounted FM fan is used (transition for fan).