

## MCP SmartFilter Ex

Filtre à cartouche pour les installations intérieures et extérieures. Il convient à la fumée, aux vapeurs, à la poussière volatile et aux poussières combustibles et peut être utilisé pour de nombreuses industries différentes.



Le MCP SmartFilter Ex est un système de filtration polyvalent. Il est personnalisable pour répondre parfaitement aux demandes spécifiques du client avec un débit d'air allant jusqu'à 28 000 m<sup>3</sup> / h. Il convient pour la fumée, les fumées et la poussière et peut être utilisé dans plusieurs applications différentes telles que le soudage, la coupe de métal et la poussière générale.

- Prenez le contrôle des performances de filtration avec Insight Analytics. Technologie de surveillance unique de Nederman
- Empreinte optimisée grâce à une conception de cartouche innovante avec un débit d'air élevé
- Coût total de possession réduit grâce à un système de nettoyage intelligent, une longue durée de vie de la cartouche filtrante et une empreinte optimisée
- Système à l'épreuve du temps préparé à l'IoT - Insight Ready
- Contrôleur, IHM et passerelle dans une seule unité avec le panneau de contrôle Insight.

Nom du produit	MCP SmartFilter Ex
Efficacité de filtration (%)	99,9
Consommation d'air comprimé	60 litres par impulsion de nettoyage à 6,0 bar d'air comprimé
Installation	Intérieur, Extérieur
Matériel	Tôle galvanisée 2 mm
Convient pour les poussières combustibles	True
Méthode de décolmatage	Jet d'air pulsé
Application	Fumée, Poussière
Pression de fonctionnement (kPa)	Dépression max. 6 kPa. Surpression max. 0 Pa. (1,5 kPa pour la solution silotop)
Volume du seau (l)	Bac de 50 ou 100 litres
Surface filtrante (m <sup>2</sup> )	Polyester: 30 - 192 m <sup>2</sup>
Capacité (débit max m <sup>3</sup> /h)	4500 à 28000
Operating Temperature	-20 to +70 Deg. C.



Fumée Poussière

# MCP SmartFilter Ex

## MCP SmartFilter Ex

### Product Marking of MCP SmartFilter Ex

CE  II 1D/3D/- c Ex h IIIC 120°C Da/Dc/-

Product marking of MCP SmartFilter Ex

Pred,max	KST	Zone Placement
0,3 bar	St1 (0 to 200 bar m s <sup>-1</sup> ) St2 (> 200 to 300 bar m s <sup>-1</sup> ) St3 (> 300 bar m s <sup>-1</sup> )*	None-zone Zone 22*

\*Not available as standard, available by request

MCP SmartFilter Ex specifications

#### Cartridge material

- SC100 – Spunbond polyester
- SC140 – Spunbond polyester with antistatic treatment
- SC141 – Spunbond polyester with antistatic treatment and PTFE coating
- SC150 – Spunbond polyester with ePTFE membrane
- SC151 – Spunbond polyester with antistatic treatment and ePTFE membrane
- SC178/SC179 – 80% cellulose, 20% polyester material with nanofiber
- SC190 – Spunbond polyester with PTFE coating

#### A – Height of Clean Air Chamber (mm)

200	350	500	650
Shown in drawings	Add 150 mm in height	Add 300 mm in height	Add 450 mm in height

















## MCP SmartFilter Ex

### Filter area

Filter type	Quantity of cartridges	Filter area (m <sup>2</sup> )			Max. airflow (m <sup>3</sup> /h)*
		SC100, SC140, SC141, SC150, SC151, SC190	SC178	SC179	
MCP-2-8S MCP-2-8S-Ex	8	48,0	105,6	52,0	7000
MCP-4-16S MCP-4-16S-Ex	16	96,0	211,2	104,0	14000
MCP-6-24S MCP-6-24S-Ex	24	144,0	316,8	156,0	21000
MCP-8-32S MCP-8-32S-Ex	32	192,0	422,4	208,0	28000
MCP-2-8SL MCP-2-8SL-Ex	8	30,4	67,2	32,8	4500
MCP-4-16SL MCP-4-16SL-Ex	16	60,8	134,4	65,6	9000
MCP-6-24SL MCP-6-24SL-Ex	24	91,2	201,6	98,4	13500
MCP-8-32SL MCP-8-32SL-Ex	32	121,6	268,8	131,2	18000

\*Max. air flow is dependent on the dust type, etc.

### Accessories

Figure	Description	Figure	Description
	Top mounted FM-fans 50 Hz or 60 Hz up to 14000 m <sup>3</sup> /h		Leg height extensions from 0 mm to 2000 mm to fit larger bins/containers, rotary valves and big bags
	Combifab remote fans 50 Hz or 60 Hz		Leg width extension 300 mm to left, right or both sides to fit larger bins/containers, rotary valves and big bags
	Noise enclosure to reduce fan and motor break-out-noise of FM-fans		Suspension below rotary valve for big bag
	Dual silencer to reduce air flow, fan noise and motor break-out-noise of FM-fans (available with grid (indoor use), grid and rain cover (outdoor use) or flange for dust connection)		Isolation box for pressure tank incl. cleaning valves
	Regulation (iris) damper at fan inlet for FM-fans		Access platform with ladder for maintenance
	Dust bins (50 l, 50 l with wheels and 100 l with wheels)		Lime feeder NFKG-70
	Plastic bag in the dust bin with pressure compensation set 'bin balancing'		Several sensors available for extraction, filtration and discharge process
	Rotary valves NRS3 and NRSZ3		Water separator and pressure regulator
	Dust discharge valve NFUS3		QF-duct system

## MCP SmartFilter Ex

MCP-2-8S / MCP-2-8S-Ex  
MCP-2-8SL / MCP-2-8SL-Ex

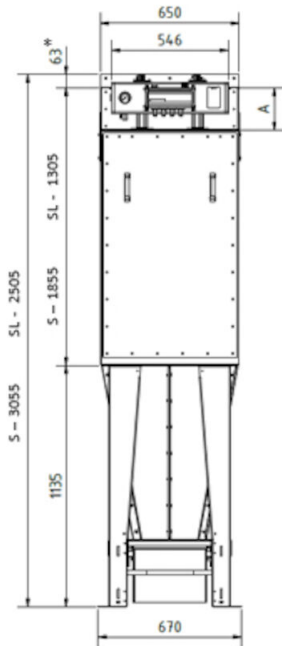

All dimensions in mm.

If 50 liter bin with wheels 90 mm must be added to the height.

\* to be included only if a top mounted FM fan is used (transition for fan).

## MCP SmartFilter Ex

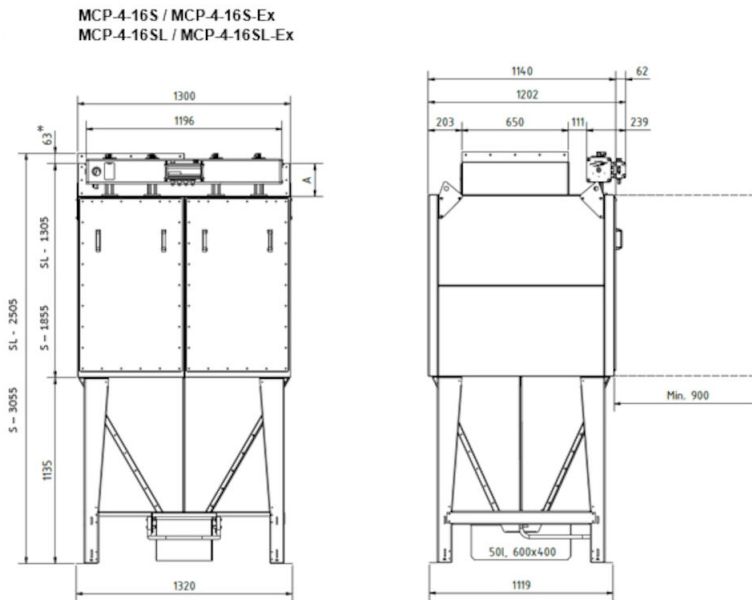

All dimensions in mm.

If 50 liter bin with wheels 90 mm must be added to the height.

\* to be included only if a top mounted FM fan is used (transition for fan).

## MCP SmartFilter Ex

MCP-6-24S / MCP-6-24S-Ex  
MCP-6-24SL / MCP-6-24SL-Ex

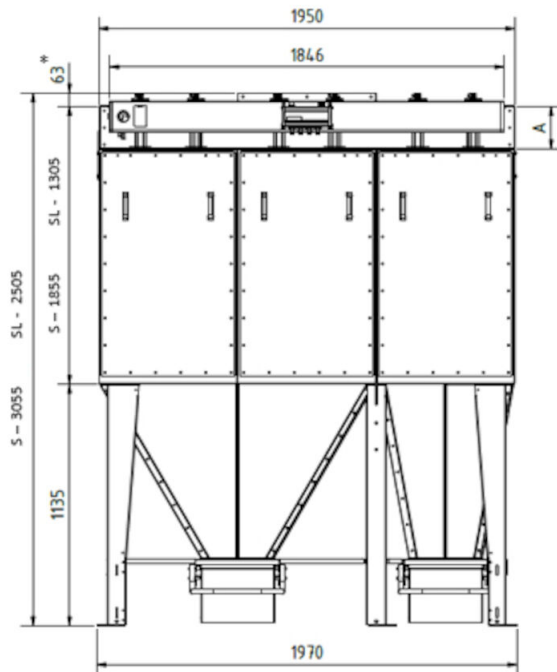

All dimensions in mm.

If 50 liter bin with wheels 90 mm must be added to the height.

\* to be included only if a top mounted FM fan is used (transition for fan).

## MCP SmartFilter Ex

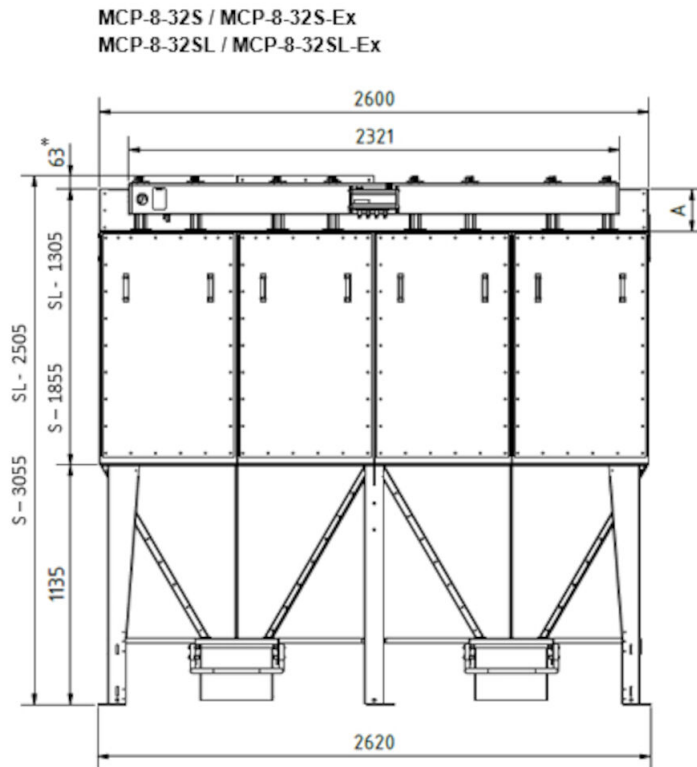

All dimensions in mm.

If 50 liter bin with wheels 90 mm must be added to the height.

\* to be included only if a top mounted FM fan is used (transition for fan).