

MCP智能除尘器 EX

滤筒过滤器适用于室内和室外安装。它适用于烟雾、粉尘和可燃粉尘，可用于多种不同行业。



MCP智能除尘器 Ex 是一种多功能过滤系统。它可根据客户的具体要求进行定制，空气流量最高可达 28 000 m³/h。适用于烟雾、粉尘和可燃粉尘，可用于焊接、金属切割和一般粉尘等多个不同应用领域。模块化设计既可提供独立的解决方案，也可提供多过滤器解决方案以满足扩展要求。采用创新的新型滤筒设计——方形滤筒能以最佳方式利用除尘器内的方形空间，并产生较高的滤筒气流。从而减小了系统的尺寸和占用空间。

它由 2 毫米镀锌钢板制成，易于安装，运输成本低廉，并具有防腐蚀功能。设计经过优化，过滤器使用寿命长，拥有成本低。

控制系统具有先进的脉冲清洗逻辑，可实现包括控制和监测在内的全系统操作，并具有用于云通信的网关功能。

它完全符合全球指令，尤其对可燃粉尘（ATEX）应用非常重要。

MCP智能除尘器有大量附件，包括风扇、入口、垃圾箱等，滤筒有多种材料可供选择。

利用尼的曼独特的监控技术控制过滤性能。

通过创新性的滤筒设计提高风量，优化滤芯占用空间。

通过智能清洁系统、延长滤芯使用寿命、优化滤芯占用空间，降低总成本。

面向未来的系统，为物联网做好准备



控制器、人机界面和网关与控制面板合而为一。

品名	MCP智能除尘器 EX
过滤效能 (%)	99,9
压缩空气消耗量	在 6.0 巴压缩空气条件下，每次清洁脉冲耗气量为 60 升
安装	室内，室外
材料	2 毫米镀锌板
适用于易爆粉尘	True
清灰方式	脉冲清灰
应用	烟气，粉尘
工作压力 (千帕)	最大真空度6kpa，最大过压 0kpa； (对于仓顶的方案最大过压允许 1,5Kpa)
灰斗容量	50 或 100 升/桶
过滤面积 (平方米)	聚酯 30 至 192 平方米
性能 (最大风量m ³ /h)	风量：4500 to 28000
工作温度	零下20-70摄氏度
除尘器类型	滤筒式过滤器
滤芯	视用途而定
技术数据声明	配置产品



烟气 粉尘

MCP智能除尘器 EX

[image]	产品名称	滤芯数量	产品编号
	MCP-2-8S-Ex 智能除尘器	8	MCP-2-8S-Ex*
	MCP-4-16S-Ex 智能除尘器	16	MCP-4-16S-Ex*
	MCP-6-24S-Ex 智能除尘器	24	MCP-6-24S-Ex*
	MCP-8-32S-Ex 智能除尘器	32	MCP-8-32S-Ex*
	MCP-2-8SL-Ex 智能除尘器	8	MCP-2-8SL-Ex*
	MCP-4-16SL-Ex 智能除尘器	16	MCP-4-16SL-Ex*
	MCP-6-24SL-Ex 智能除尘器	24	MCP-6-24SL-Ex*
	MCP-8-32SL-Ex 智能除尘器	32	MCP-8-32SL-Ex*

*配置产品

MCP智能除尘器 EX

Product Marking of MCP SmartFilter Ex

CE  II 1D/3D/- c Ex h IIIC 120°C Da/Dc/-

Product marking of MCP SmartFilter Ex

Pred,max	KST	Zone Placement
0,3 bar	St1 (0 to 200 bar m s ⁻¹) St2 (> 200 to 300 bar m s ⁻¹) St3 (> 300 bar m s ⁻¹)*	None-zone Zone 22*

*Not available as standard, available by request

MCP SmartFilter Ex specifications

Cartridge material

- SC100 – Spunbond polyester
- SC140 – Spunbond polyester with antistatic treatment
- SC141 – Spunbond polyester with antistatic treatment and PTFE coating
- SC150 – Spunbond polyester with ePTFE membrane
- SC151 – Spunbond polyester with antistatic treatment and ePTFE membrane
- SC178/SC179 – 80% cellulose, 20% polyester material with nanofiber
- SC190 – Spunbond polyester with PTFE coating

A – Height of Clean Air Chamber (mm)

200	350	500	650
Shown in drawings	Add 150 mm in height	Add 300 mm in height	Add 450 mm in height











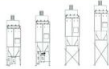





MCP智能除尘器 EX

Filter area

Filter type	Quantity of cartridges	Filter area (m ²)			Max. airflow (m ³ /h)*
		SC100, SC140, SC141, SC150, SC151, SC190	SC178	SC179	
MCP-2-8S MCP-2-8S-Ex	8	48,0	105,6	52,0	7000
MCP-4-16S MCP-4-16S-Ex	16	96,0	211,2	104,0	14000
MCP-6-24S MCP-6-24S-Ex	24	144,0	316,8	156,0	21000
MCP-8-32S MCP-8-32S-Ex	32	192,0	422,4	208,0	28000
MCP-2-8SL MCP-2-8SL-Ex	8	30,4	67,2	32,8	4500
MCP-4-16SL MCP-4-16SL-Ex	16	60,8	134,4	65,6	9000
MCP-6-24SL MCP-6-24SL-Ex	24	91,2	201,6	98,4	13500
MCP-8-32SL MCP-8-32SL-Ex	32	121,6	268,8	131,2	18000

*Max. air flow is dependent on the dust type, etc.

Accessories

Figure	Description	Figure	Description
	Top mounted FM-fans 50 Hz or 60 Hz up to 14000 m ³ /h		Leg height extensions from 0 mm to 2000 mm to fit larger bins/containers, rotary valves and big bags
	Combifab remote fans 50 Hz or 60 Hz		Leg width extension 300 mm to left, right or both sides to fit larger bins/containers, rotary valves and big bags
	Noise enclosure to reduce fan and motor break-out-noise of FM-fans		Suspension below rotary valve for big bag
	Dual silencer to reduce air flow, fan noise and motor break-out-noise of FM-fans (available with grid (indoor use), grid and rain cover (outdoor use) or flange for dust connection)		Isolation box for pressure tank incl. cleaning valves
	Regulation (iris) damper at fan inlet for FM-fans		Access platform with ladder for maintenance
	Dust bins (50 l, 50 l with wheels and 100 l with wheels)		Lime feeder NFKG-70
	Plastic bag in the dust bin with pressure compensation set 'bin balancing'		Several sensors available for extraction, filtration and discharge process
	Rotary valves NRS3 and NRSZ3		Water separator and pressure regulator
	Dust discharge valve NFUS3		QF-duct system

MCP智能除尘器 EX

MCP-2-8S / MCP-2-8S-Ex
MCP-2-8SL / MCP-2-8SL-Ex

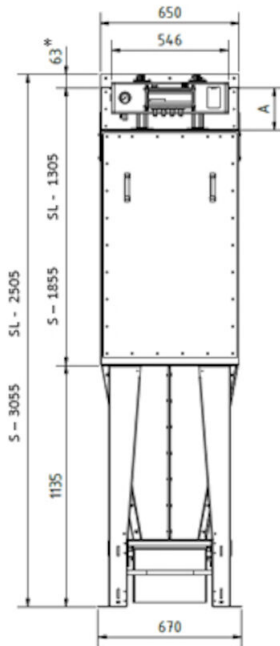

All dimensions in mm.

If 50 liter bin with wheels 90 mm must be added to the height.

* to be included only if a top mounted FM fan is used (transition for fan).

MCP智能除尘器 EX

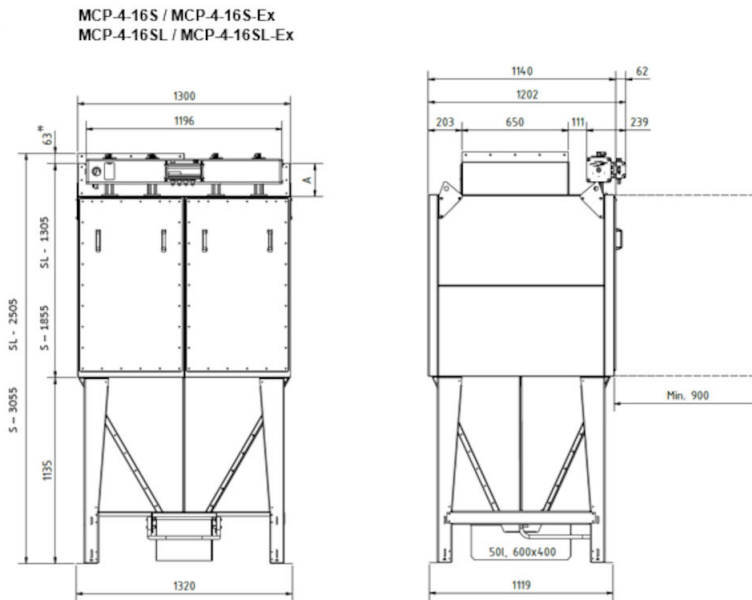

All dimensions in mm.

If 50 liter bin with wheels 90 mm must be added to the height.

* to be included only if a top mounted FM fan is used (transition for fan).

MCP智能除尘器 EX

MCP-6-24S / MCP-6-24S-Ex
MCP-6-24SL / MCP-6-24SL-Ex

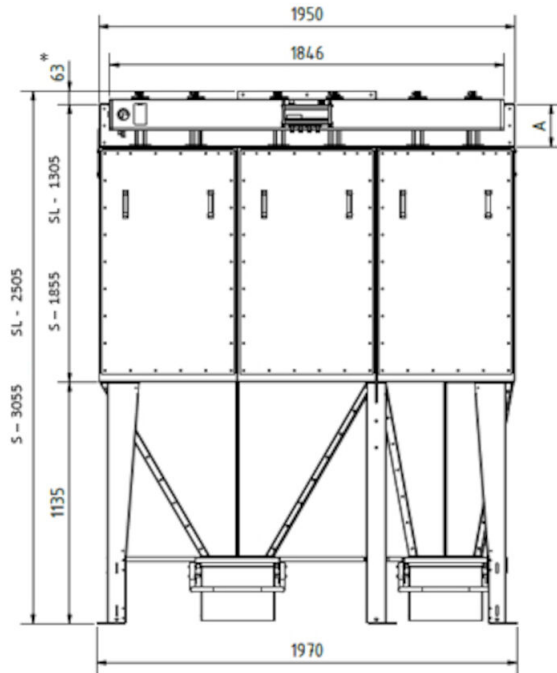

All dimensions in mm.

If 50 liter bin with wheels 90 mm must be added to the height.

* to be included only if a top mounted FM fan is used (transition for fan).

MCP智能除尘器 EX

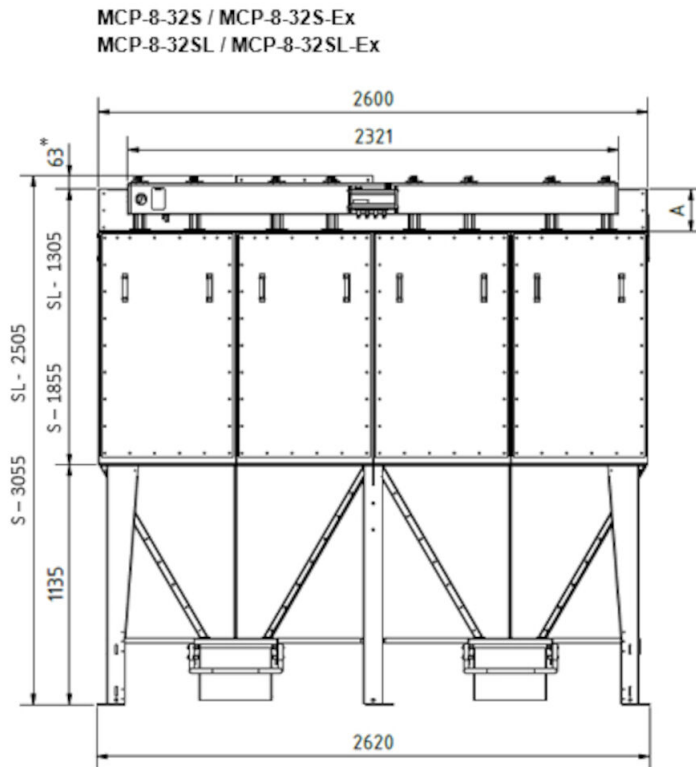

All dimensions in mm.

If 50 liter bin with wheels 90 mm must be added to the height.

* to be included only if a top mounted FM fan is used (transition for fan).