

MEP SmartFilter Ex

MEP SmartFilter Ex is a multi-purpose filtration system. It is customizable to perfectly fit customer specific demands with airflow up to 10 500 m³/h.

MEP SmartFilter Ex



MEP SmartFilter Ex je víceúčelový kapsový filtrační systém. Je přizpůsobitelný tak, aby dokonale vyhovoval specifickým požadavkům zákazníka. Vhodný pro různé typy prachu včetně hořlavého prachu a lze jej použít v několika různých aplikacích, jako je broušení, tryskání a běžný prach.

Modulární konstrukce umožňuje samostatná řešení i řešení s více filtry pro rozšířené požadavky.

MEP používá naše dlouho zavedené látkové kapsové filtry, které lze snadno udržovat pomocí předních výklopných dveří.

K dispozici jsou filtrační materiály pro většinu aplikací, v závislosti na typu prachu, zatížení prachem a požadavcích na účinnost.

Je vyroben z pozinkovaných ocelových panelů o tloušťce 2 mm, je snadno instalovatelný, nákladově efektivní a poskytuje ochranu proti korozi. Konstrukce je optimalizována pro dlouhou životnost filtru a poskytuje nízké náklady na provoz.

"Insight" řídicí systém s pokročilou logikou čištění pulsů zajišťuje plnou funkčnost systému včetně řízení, monitorování a přenosem dat pro cloudovou komunikaci.

MEP SmartFilter má velkou nabídku příslušenství včetně ventilátorů, přívodů, sběrného koše apod. a kazety jsou dostupné v široké škále materiálů.

- Získejte kontrolu nad výkonem filtrace pomocí Insight Analytics. Unikátní monitorovací technologie společnosti Nederman
- Optimalizovaný půdorys díky inovativní konstrukci kazety s vysokým průtokem vzduchu
- Snížení TCO díky inteligentnímu systému čištění, dlouhé životnosti filtru a optimalizovanému půdorysu
- Řídicí systém "Insight System" je systém budoucnosti a připraven pro IoT









Název produktu	MEP SmartFilter Ex
Spotřeba stlačeného vzduchu	58 litrů na čisticí impuls při stlačeném vzduchu 5,5 bar
Instalace	Vnitřní, Vnější
Materiál	Pozinkovaná ocel
Vhodné pro výbušný prach	True
Metoda čištění filtru	Proplachová tryska
Použití	Dýmy, Prach
Pracovní tlak (kPa)	Podtlak max. 6 kPa Přetlak max. 0 Pa. (1,5 kPa pro řešení bez výsypky)
Objem sběrné nádoby (l)	50 nebo 100 l sběrná nádoba
Filtrační plocha (m ²)	15 - 88
Kapacita (max. průtok m ³ /h)	1800 - 10500
Pracovní teplota	-20°C to +70°C
Typ filtru	Kazetový filtr
Materiál filtru	Závisí na použití



MEP SmartFilter Ex















Dýmý Prach

MEP SmartFilter Ex

[image]	Jméno datasheetu	Počet filtračních elementů	[model]
	MEP-4-4-Ex Smartfilter	4	MEP-4-4-Ex
	MEP-6-4-Ex Smartfilter	6	MEP-6-4-Ex
	MEP-8-4-Ex Smartfilter	8	MEP-8-4-Ex
	MEP-2-6-Ex Smartfilter	2	MEP-2-6-Ex
	MEP-4-6-Ex Smartfilter	4	MEP-4-6-Ex
	MEP-6-6-Ex Smartfilter	6	MEP-6-6-Ex
	MEP-8-6-Ex Smartfilter	8	MEP-8-6-Ex
	MEP-2-4-Ex SmartFilter	2	MEP-2-4-Ex

MEP SmartFilter Ex

Accessories

Figure	Description	Figure	Description
	Top mounted FM-fans 50 Hz or 60 Hz up to 14000 m ³ /h		Leg height extensions from 0 mm to 2000 mm to fit larger bins/containers, rotary valves and big bags
	Combifab remote fans 50 Hz or 60 Hz		Leg width extension 300 mm to left, right or both sides to fit larger bins/containers, rotary valves and big bags
	Noise enclosure to reduce fan and motor break-out-noise of FM-fans		Suspension below rotary valve for big bag
	Dual silencer to reduce air flow, fan noise and motor break-out-noise of FM-fans (available with grid (indoor use), grid and rain cover (outdoor use) or flange for duct connection)		Isolation box for pressure tank incl. clearing valves
	Regulation (iris) damper at fan inlet for FM-fans		Access platform with ladder for maintenance
	Dust bins (50 l, 50 l with wheels and 100 l with wheels)		Lime feeder NFKG-70
	Plastic bag in the dust bin with pressure compensation set 'bin balancing'		Several sensors available for extraction, filtration and discharge process
	Rotary valves NRS3 and NRSZ3		Water separator and pressure regulator
	Dust discharge valve NFUS3		QF-duct system

Envelope material

- NF100 – Polyester needlefelt, singed, 500 g/m²
- NF130 – Polyester needlefelt, glazed, 500 g/m²
- NF141 – Polyester needlefelt, glazed, 400 g/m², antistatic
- NF142 – Polyester needlefelt, glazed, 500 g/m², antistatic
- NF143 – Polyester needlefelt, PTFE coating, 550 g/m², antistatic
- NF180 – Polyester needlefelt, glazed, 550 g/m²
- NF181 – Polyester needlefelt, PTFE coating, 550 g/m²

MCP Envelope material

MEP SmartFilter Ex

A – Height of Clean Air Chamber (mm)			
200	350	500	650
Shown in drawings	Add 150 mm in height	Add 300 mm in height	Add 450 mm in height

MEP A - height of clean air chamber

Product Marking of MEP SmartFilter Ex

  II 1D/3D/- c Ex h IIIC 120°C Da/Dc/-

MEP SmartFilter Ex marking

Pred.max	KST	Zone Placement
0,3 bar	S11 (0 to 200 bar m s ⁻¹) S12 (> 200 to 300 bar m s ⁻¹) S13 (> 300 bar m s ⁻¹)*	None-zone Zone 22*

*Not available as standard, available by request

MEP SmartFilter Ex specifications

Filter area

Filter type	Quantity of envelopes	Filter area (m ²)	Max. airflow (m ³ /h)*
MEP-2-4 MEP-2-4-Ex	2	15	1800
MEP-4-4 MEP-4-4-Ex	4	29	3400
MEP-6-4 MEP-6-4-Ex	6	44	5200
MEP-8-4 MEP-8-4-Ex	8	58	7000
MEP-2-6 MEP-2-6-Ex	2	22	2600
MEP-4-6 MEP-4-6-Ex	4	44	5200
MEP-6-6 MEP-6-6-Ex	6	66	8000
MEP-8-6 MEP-8-6-Ex	8	88	10500

*Max. air flow is dependent on the dust type, etc.

MEP Filter area

MEP SmartFilter Ex

MEP-2.4 / MEP-2.4-Ex
MEP-2.6 / MEP-2.6-Ex

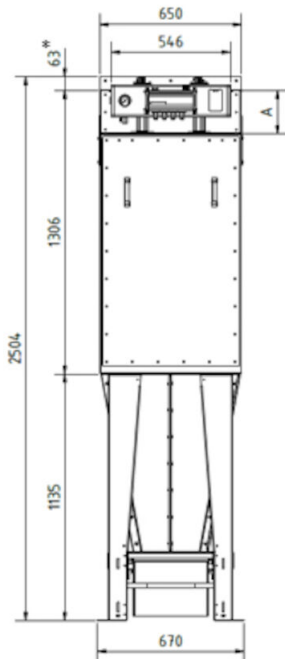

All dimensions in mm.

If 50 liter bin with wheels 90 mm must be added to the height.

* to be included only if a top mounted FM fan is used (transition for fan).

MEP SmartFilter Ex

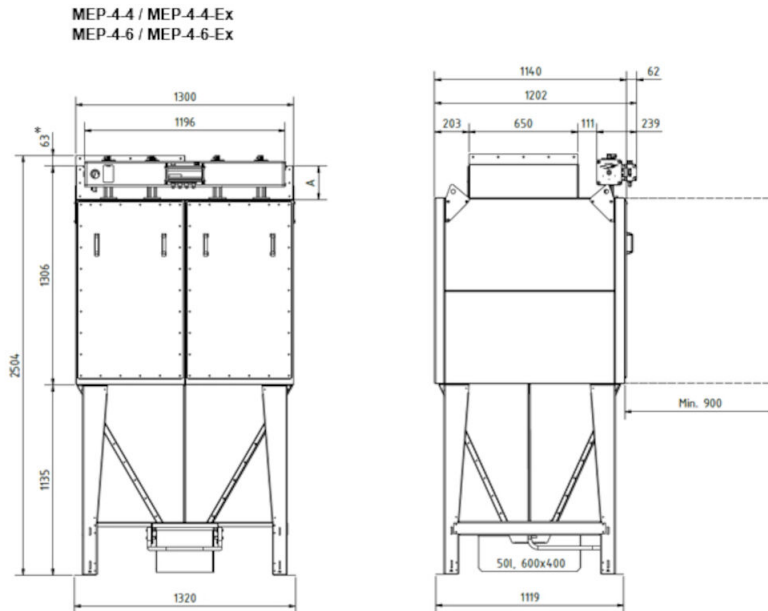

All dimensions in mm.

If 50 liter bin with wheels 90 mm must be added to the height.

* to be included only if a top mounted FM fan is used (transition for fan).

MEP SmartFilter Ex

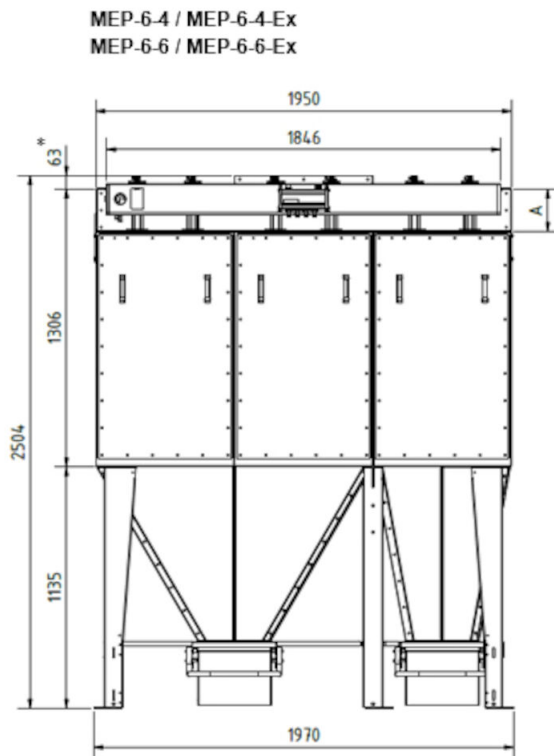

All dimensions in mm.

If 50 liter bin with wheels 90 mm must be added to the height.

* to be included only if a top mounted FM fan is used (transition for fan).

MEP SmartFilter Ex

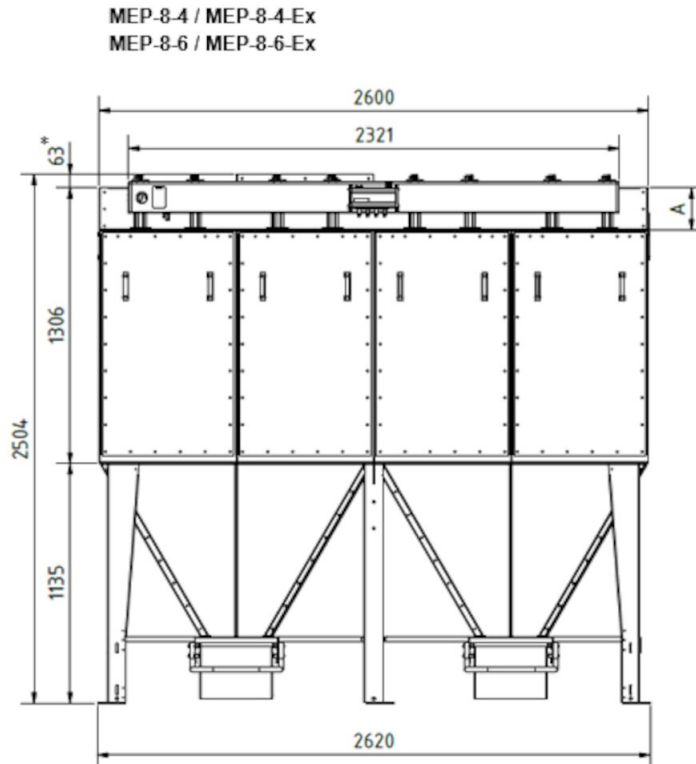

All dimensions in mm.

If 50 liter bin with wheels 90 mm must be added to the height.

* to be included only if a top mounted FM fan is used (transition for fan).