

MEP SmartFilter Ex

MEP SmartFilter Ex is a multi-purpose filtration system. It is customizable to perfectly fit customer specific demands with airflow up to 10 500 m³/h.

MEP SmartFilter Ex



MEP SmartFilter is een multifunctioneel filtersysteem. Het systeem is aanpasbaar om de perfecte oplossing te bieden voor klantspecifieke wensen. Geschikt voor het filteren van verschillende stoffen, waaronder ook explosiegevaarlijke stoffen en inzetbaar voor verschillende toepassingen zoals, slijpen, stralen en algemene stoftoepassingen. Het modulaire ontwerp maakt een stand-alone oplossing mogelijk en op een later gewenst moment kan het filtersysteem zelfs verder worden uitgebreid. Het MEP SmartFilter is uitgevoerd met enveloppen filters die eenvoudig te onderhouden zijn. De enveloppen filters zijn voor veel stoftoepassingen beschikbaar. Dit is afhankelijk van het type stof, de stofbelasting en de efficiëntie eisen. Het SmartFilter is gemaakt van 2 mm plaatstaal, eenvoudig te installeren en corrosiebestendig. Het ontwerp is verder geoptimaliseerd en zorgt voor een lange levensduur van het filter en daardoor ook lagere gebruikskosten. "Insight Ready" besturing voorzien van geavanceerde pulsreiniging zorgt voor een volledige systeembediening inclusief bewaking en gateway functionaliteit voor Cloud communicatie. Het MEP SmartFilter heeft een compleet programma met accessoires waaronder ventilatoren, inlaten, stofopvangbakken en een breed scala aan verschillende filtermaterialen.









- Krijg controle over uw filterprestaties met Nederman Insight Analytics. De unieke bewakingstechnologie van Nederman.
- Geoptimaliseerde vloeroppervlakte door innovatief filter cartridge ontwerp met hoge luchtstroom
- Lagere gebruikskosten door intelligent reinigingssysteem en daardoor ook langere levensduur van de filterpatronen
- Een filtersysteem voor de toekomst dat is voorbereid op IoT - en "Insight Ready"
- Controller, HMI en gateway allemaal in één unit met het Nederman Insight bedieningspaneel

Product naam	MEP SmartFilter Ex
Persluchtverbruik	58 liter per reinigingspuls bij 5,5 Bar perslucht
Installatie	Binnen, Buiten
Materiaal	Gegalvaniseerd staal
Geschikt voor explosief stof	True
Filter reinigingsmethode	Perslucht
Applicatie	Dampen, Stof
Werkdruk (kPa)	Max. vacuüm 6 kPa. Max. overdruk 0 Pa. (1,5 kPa voor silotop oplossing)
Volume opvangbak (l)	50 of 100 liter opvangbak
Filteroppervlakte (m ²)	15 - 88
Capaciteit (max. luchtstroom m ³ per uur)	1.800 - 10.500
Operating Temperature	-20 tot +70 graden Celsius
Filtertype	Cassette filter
Filtermateriaal	Afhankelijk van de toepassing

MEP SmartFilter Ex

















MEP SmartFilter Ex

[image]	Naam voor Datasheet	Aantal filterelementen	[model]
	MEP SmartFilter Ex 4-4	4	MEP-4-4-Ex
	MEP SmartFilter Ex 6-4	6	MEP-6-4-Ex
	MEP SmartFilter Ex 8-4	8	MEP-8-4-Ex
	MEP SmartFilter Ex 2-6	2	MEP-2-6-Ex
	MEP SmartFilter Ex 4-6	4	MEP-4-6-Ex
	MEP SmartFilter Ex 6-6	6	MEP-6-6-Ex
	MEP SmartFilter Ex 8-6	8	MEP-8-6-Ex
	MEP SmartFilter Ex 2-4	2	MEP-2-4-Ex

MEP SmartFilter Ex

Accessories

Figure	Description	Figure	Description
	Top mounted FM-fans 50 Hz or 60 Hz up to 14000 m ³ /h		Leg height extensions from 0 mm to 2000 mm to fit larger bins/containers, rotary valves and big bags
	Combifab remote fans 50 Hz or 60 Hz		Leg width extension 300 mm to left, right or both sides to fit larger bins/containers, rotary valves and big bags
	Noise enclosure to reduce fan and motor break-out-noise of FM-fans		Suspension below rotary valve for big bag
	Dual silencer to reduce air flow, fan noise and motor break-out-noise of FM-fans (available with grid (indoor use), grid and rain cover (outdoor use) or flange for duct connection)		Isolation box for pressure tank incl. clearing valves
	Regulation (iris) damper at fan inlet for FM-fans		Access platform with ladder for maintenance
	Dust bins (50 l, 50 l with wheels and 100 l with wheels)		Lime feeder NFKG-70
	Plastic bag in the dust bin with pressure compensation set 'bin balancing'		Several sensors available for extraction, filtration and discharge process
	Rotary valves NRS3 and NRSZ3		Water separator and pressure regulator
	Dust discharge valve NFUS3		QF-duct system

Envelope material

- NF100 – Polyester needlefelt, singed, 500 g/m²
- NF130 – Polyester needlefelt, glazed, 500 g/m²
- NF141 – Polyester needlefelt, glazed, 400 g/m², antistatic
- NF142 – Polyester needlefelt, glazed, 500 g/m², antistatic
- NF143 – Polyester needlefelt, PTFE coating, 550 g/m², antistatic
- NF180 – Polyester needlefelt, glazed, 550 g/m²
- NF181 – Polyester needlefelt, PTFE coating, 550 g/m²

MCP Envelope material

MEP SmartFilter Ex

A – Height of Clean Air Chamber (mm)			
200	350	500	650
Shown in drawings	Add 150 mm in height	Add 300 mm in height	Add 450 mm in height

MEP A - height of clean air chamber

Product Marking of MEP SmartFilter Ex

  II 1D/3D/- c Ex h IIIC 120°C Da/Dc/-

MEP SmartFilter Ex marking

Pred.max	KST	Zone Placement
0,3 bar	S11 (0 to 200 bar m s ⁻¹) S12 (> 200 to 300 bar m s ⁻¹) S13 (> 300 bar m s ⁻¹)*	None-zone Zone 22*

*Not available as standard, available by request

MEP SmartFilter Ex specifications

Filter area

Filter type	Quantity of envelopes	Filter area (m ²)	Max. airflow (m ³ /h)*
MEP-2-4 MEP-2-4-Ex	2	15	1800
MEP-4-4 MEP-4-4-Ex	4	29	3400
MEP-6-4 MEP-6-4-Ex	6	44	5200
MEP-8-4 MEP-8-4-Ex	8	58	7000
MEP-2-6 MEP-2-6-Ex	2	22	2600
MEP-4-6 MEP-4-6-Ex	4	44	5200
MEP-6-6 MEP-6-6-Ex	6	66	8000
MEP-8-6 MEP-8-6-Ex	8	88	10500

*Max. air flow is dependent on the dust type, etc.

MEP Filter area

MEP SmartFilter Ex

MEP-2.4 / MEP-2.4-Ex
MEP-2.6 / MEP-2.6-Ex

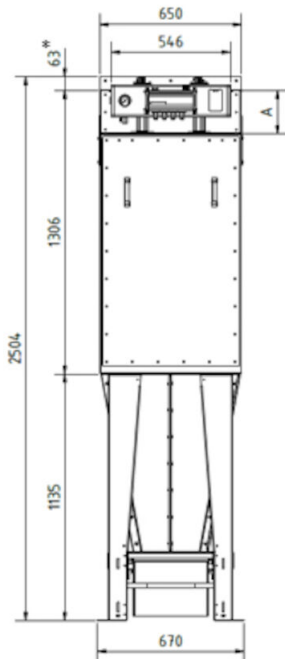

All dimensions in mm.

If 50 liter bin with wheels 90 mm must be added to the height.

* to be included only if a top mounted FM fan is used (transition for fan).

MEP SmartFilter Ex

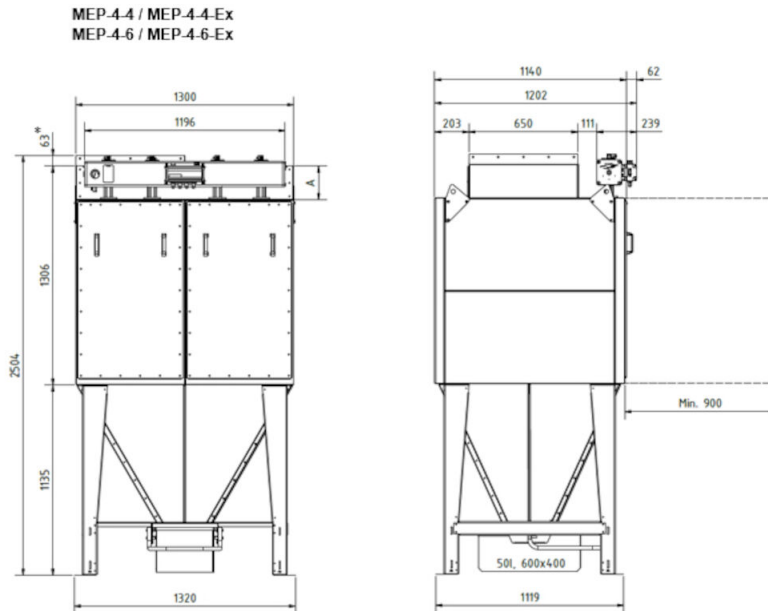

All dimensions in mm.

If 50 liter bin with wheels 90 mm must be added to the height.

* to be included only if a top mounted FM fan is used (transition for fan).

MEP SmartFilter Ex

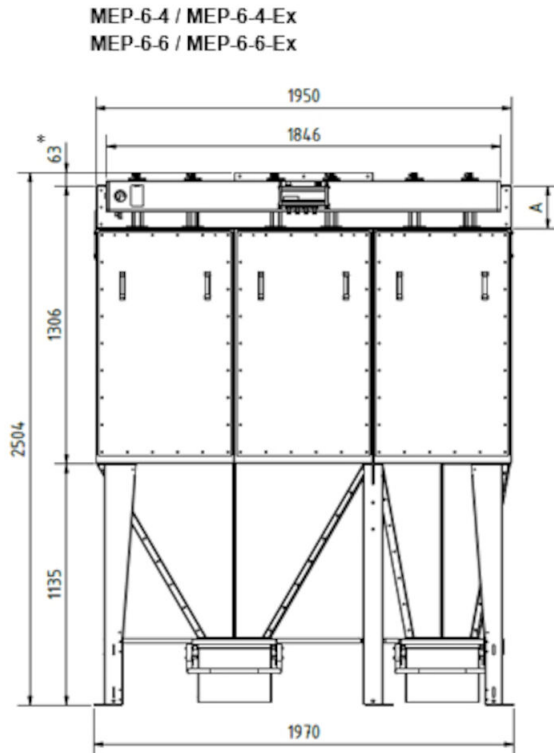

All dimensions in mm.

If 50 liter bin with wheels 90 mm must be added to the height.

* to be included only if a top mounted FM fan is used (transition for fan).

MEP SmartFilter Ex

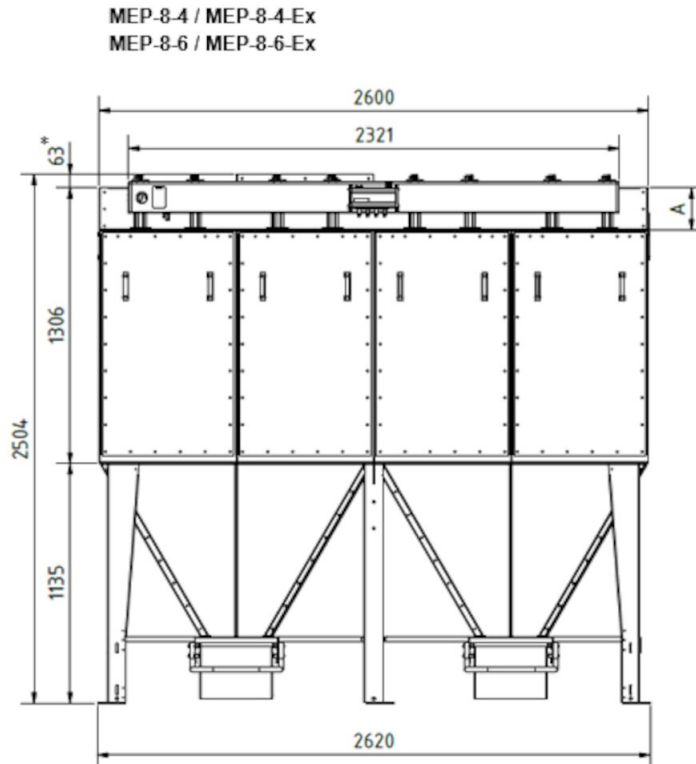

All dimensions in mm.

If 50 liter bin with wheels 90 mm must be added to the height.

* to be included only if a top mounted FM fan is used (transition for fan).