

## MEP SmartFilter Ex

MEP Smartfilter EX är ett multifunktions filteringsystem. Det är anpassningsbart för att användas vid luftflöden upp till 10.500 m<sup>3</sup>/h.

---

## MEP SmartFilter Ex



MEP Smartfilter EX är ett multifunktions filteringsystem. Det är anpassningsbart för att användas vid luftflöden upp till 10.500 m<sup>3</sup>/h. MEP Smartfilter är lämplig för torrt damm och brännbart damm och kan användas i flera olika tillämpningar såsom metallslipning, skärning av metall, blästring och allmänt damm.

Den modulära konstruktionen möjliggör fristående lösningar likaväl som multifunktionslösningar vid utökat behov.

MEP Smartfilter EX använder våra etablerade kuvertfilter som man enkelt kan underhålla genom de främre gångjärnsupphängda dörrarna.

Filtermaterial för de flesta applikationer finns tillgängliga. Valet beror på dammtyp, dammbelastning och effektivitetskrav.

Enheten är konstruerad med 2 mm galvaniserade stålpaneler och är enkelt att installera, kostnadseffektivt att skicka och har ett korrosionsskydd. Konstruktionen är optimerad för lång filterlivslängd vilket ger låga produktivslängdskostnader.

"Insight ready" med avancerad pulsrengöringslogik ger full systemdrift inklusive styrning och övervakning samt gatewayfunktioner för molnkommunikation.

MEP SmartFilter EX har ett stort tillbehörsprogram inklusive; fläktar, inlopp, behållare för bortfiltrerat material etc. och med en variation filterpatronerna beroende av vad som filtreras.

- Få kontroll över filtreringsprocessen med Insight Analytics. Nedermans unika övervakningsteknik
- Optimerad "footprint" tack vare innovativ filterpatrondesign med högt luftflöde.
- Reducerad total kostnad tack vare intelligent rensningssystem och lång livslängd på filterpatroner.
- Framtidsförberedd filtersystem som är IoT anpassat - Insight Ready

|   |  |
|---|--|
| Produkt namn                                | MEP SmartFilter Ex   |
| Tryckluftsförbrukning                       | 58 litres per cleaning pulse at 5,5 bar compressed air                       |
| Installation                                | Inomhus, Utomhus   |
| Material                                    | 2 mm galvaniserad plåt   |
| Lämplig för explosivt damm                  | True   |
| Metod för filterrensning                    | Puls jet   |
| Applikation                                 | Rök, Stoft   |
| Arbetsstryck (kPa)                          | Vacuum max. 6 kPa.<br>Overpressure max. 0 Pa. (1,5 kPa for silotop solution) |
| Volym stoftbehållare (l)                    | 50 eller 100 liters behållare  |
| Filterarea (m <sup>2</sup> )                | 15 - 88  |
| Kapacitet (max luftflöde m <sup>3</sup> /h) | 1800 - 10500   |
| Temperaturområde                            | -20°C till +70°C   |

## MEP SmartFilter Ex

|                |               |
|----------------|---------------|
| Typ av filter  | Kassettfilter |
| Filtermaterial |               |











Rök



Stoft











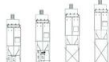



## MEP SmartFilter Ex

| Bild  | Beskrivning            | Antal filter | Model      |
|---|------------------------|--------------|------------|
|    | MEP-4-4-Ex Smartfilter | 4            | MEP-4-4-Ex |
|    | MEP-6-4-Ex Smartfilter | 6            | MEP-6-4-Ex |
|    | MEP-8-4-Ex Smartfilter | 8            | MEP-8-4-Ex |
|    | MEP-2-6-Ex Smartfilter | 2            | MEP-2-6-Ex |
|    | MEP-4-6-Ex Smartfilter | 4            | MEP-4-6-Ex |
|   | MEP-6-6-Ex Smartfilter | 6            | MEP-6-6-Ex |
|  | MEP-8-6-Ex Smartfilter | 8            | MEP-8-6-Ex |
|  | MEP-2-4-Ex SmartFilter | 2            | MEP-2-4-Ex |

## MEP SmartFilter Ex

### Accessories

| Figure  | Description  | Figure  | Description   |
|---|--|---|---|
|    | Top mounted FM-fans 50 Hz or 60 Hz up to 14000 m <sup>3</sup> /h   |    | Leg height extensions from 0 mm to 2000 mm to fit larger bins/containers, rotary valves and big bags              |
|    | Combifab remote fans 50 Hz or 60 Hz  |    | Leg width extension 300 mm to left, right or both sides to fit larger bins/containers, rotary valves and big bags |
|    | Noise enclosure to reduce fan and motor break-out-noise of FM-fans   |    | Suspension below rotary valve for big bag   |
|    | Dual silencer to reduce air flow, fan noise and motor break-out-noise of FM-fans (available with grid (indoor use), grid and rain cover (outdoor use) or flange for duct connection) |    | Isolation box for pressure tank incl. clearing valves   |
|    | Regulation (iris) damper at fan inlet for FM-fans  |    | Access platform with ladder for maintenance   |
|    | Dust bins (50 l, 50 l with wheels and 100 l with wheels)   |    | Lime feeder NFKG-70   |
|   | Plastic bag in the dust bin with pressure compensation set 'bin balancing'   |   | Several sensors available for extraction, filtration and discharge process  |
|  | Rotary valves NRS3 and NRSZ3   |  | Water separator and pressure regulator  |
|  | Dust discharge valve NFUS3   |  | QF-duct system  |

### Envelope material

- NF100 – Polyester needlefelt, singed, 500 g/m<sup>2</sup>
- NF130 – Polyester needlefelt, glazed, 500 g/m<sup>2</sup>
- NF141 – Polyester needlefelt, glazed, 400 g/m<sup>2</sup>, antistatic
- NF142 – Polyester needlefelt, glazed, 500 g/m<sup>2</sup>, antistatic
- NF143 – Polyester needlefelt, PTFE coating, 550 g/m<sup>2</sup>, antistatic
- NF180 – Polyester needlefelt, glazed, 550 g/m<sup>2</sup>
- NF181 – Polyester needlefelt, PTFE coating, 550 g/m<sup>2</sup>

MCP Envelope material

## MEP SmartFilter Ex

| A – Height of Clean Air Chamber (mm) |                      |                      |                      |
|--------------------------------------|----------------------|----------------------|----------------------|
| 200                                  | 350                  | 500                  | 650                  |
| Shown in drawings                    | Add 150 mm in height | Add 300 mm in height | Add 450 mm in height |

MEP A - height of clean air chamber

### Product Marking of MEP SmartFilter Ex



 II 1D/3D/- c Ex h IIIC 120°C Da/Dc/-

MEP SmartFilter Ex marking

| Pred.max | KST   | Zone Placement        |
|----------|---|-----------------------|
| 0,3 bar  | S11 (0 to 200 bar m s <sup>-1</sup> )<br>S12 (> 200 to 300 bar m s <sup>-1</sup> )<br>S13 (> 300 bar m s <sup>-1</sup> )* | None-zone<br>Zone 22* |

\*Not available as standard, available by request

MEP SmartFilter Ex specifications

#### Filter area

| Filter type           | Quantity of envelopes | Filter area (m <sup>2</sup> ) | Max. airflow (m <sup>3</sup> /h)* |
|-----------------------|-----------------------|-------------------------------|-----------------------------------|
| MEP-2-4<br>MEP-2-4-Ex | 2                     | 15                            | 1800                              |
| MEP-4-4<br>MEP-4-4-Ex | 4                     | 29                            | 3400                              |
| MEP-6-4<br>MEP-6-4-Ex | 6                     | 44                            | 5200                              |
| MEP-8-4<br>MEP-8-4-Ex | 8                     | 58                            | 7000                              |
| MEP-2-6<br>MEP-2-6-Ex | 2                     | 22                            | 2600                              |
| MEP-4-6<br>MEP-4-6-Ex | 4                     | 44                            | 5200                              |
| MEP-6-6<br>MEP-6-6-Ex | 6                     | 66                            | 8000                              |
| MEP-8-6<br>MEP-8-6-Ex | 8                     | 88                            | 10500                             |

\*Max. air flow is dependent on the dust type, etc.

MEP Filter area

## MEP SmartFilter Ex

MEP-2.4 / MEP-2.4-Ex  
MEP-2.6 / MEP-2.6-Ex

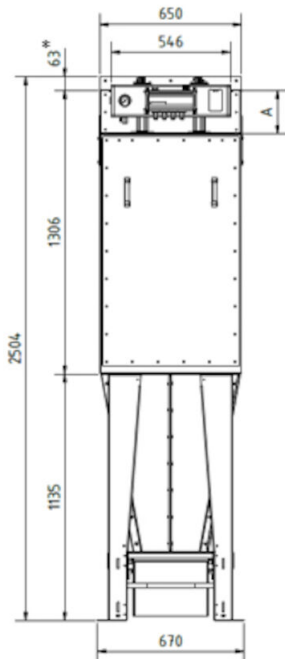

All dimensions in mm.

If 50 liter bin with wheels 90 mm must be added to the height.

\* to be included only if a top mounted FM fan is used (transition for fan).

## MEP SmartFilter Ex

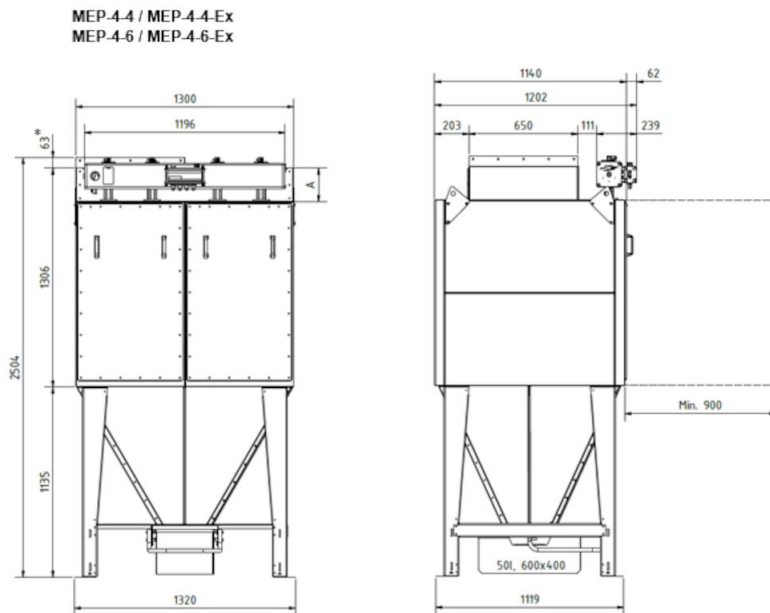

All dimensions in mm.

If 50 liter bin with wheels 90 mm must be added to the height.

\* to be included only if a top mounted FM fan is used (transition for fan).



## MEP SmartFilter Ex

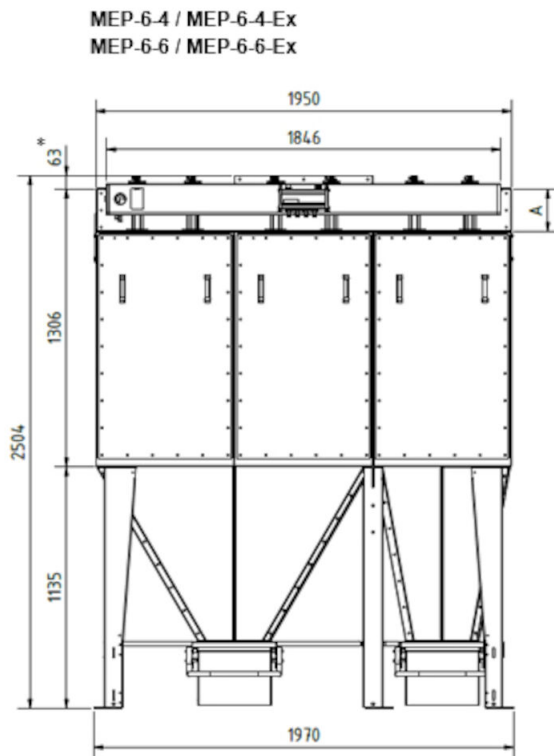

All dimensions in mm.

If 50 liter bin with wheels 90 mm must be added to the height.

\* to be included only if a top mounted FM fan is used (transition for fan).

## MEP SmartFilter Ex

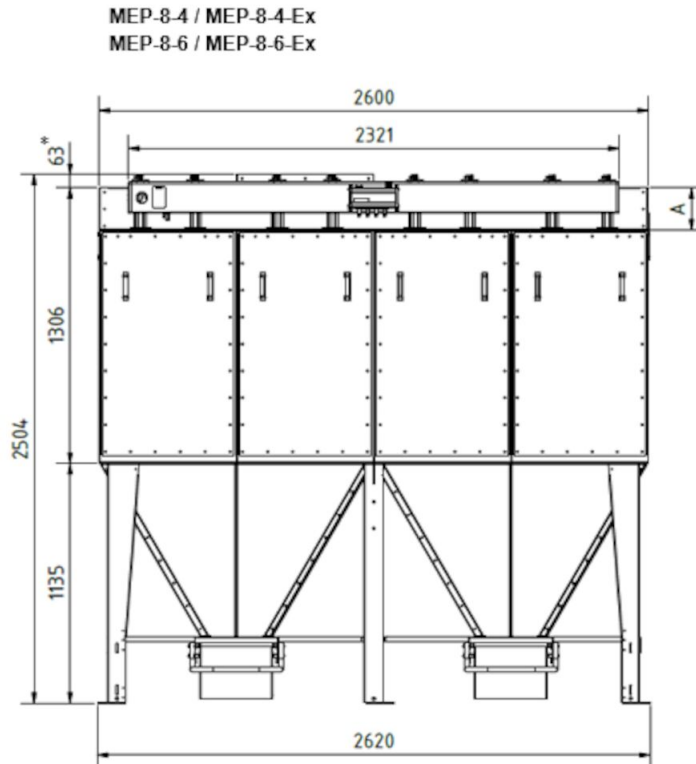

All dimensions in mm.

If 50 liter bin with wheels 90 mm must be added to the height.

\* to be included only if a top mounted FM fan is used (transition for fan).