

MEP Ex Akıllı filtre

MEP SmartFilter çok amaçlı kullanım için tasarlanmış bir filtreleme sistemidir. 10500 m³ / saate kadar hava akışıyla müşterinin özel taleplerine uygun şekilde özelleştirilebilir.

MEP Ex Akıllı filtre



MEP SmartFilter çok amaçlı bir filtreleme sistemidir. Müşteriye özel taleplerine uygun şekilde özelleştirilebilir. Farklı toz türleri için uygundur ve taşlama, kuşlama ve genel toz gibi birkaç farklı uygulamada kullanılabilir.

Modüler tasarım, bağımsız çözümlere ve genişletilmiş gereksinimler için çoklu filtre çözümlerine izin verir. MEP toz toplayıcı, önden menteşeli kapılardan kolayca bakımı yapılabilen, köklü kumaş zarflarımızı kullanır.

Toz tipine, toz yüküne ve verimlilik gereksinimlerine bağlı olarak çoğu uygulama için filtre zarf malzemeleri mevcuttur.

2 mm galvaniz çelik panellerden imal edilmiştir, montajı kolaydır, nakliyesi düşük maliyetlidir ve korozyona karşı koruma sağlar.

Tasarım, düşük sahip olma maliyeti sağlayan uzun filtre ömrü için optimize edilmiştir.

Gelişmiş darbe temizleme mantığına sahip sezgiye hazır kontrol, kontrol ve izleme dahil olmak üzere tam sistem operasyonu ve bulut ağ iletişimi için ağlar arası geçiş işlevi sağlar.

MEP SmartFilter, aşağıdakileri içeren geniş bir aksesuar programına sahiptir: fanlar, girişler, kovalar vb. ve torbalar çok çeşitli malzemelerden temin edilebilir.

- Nederman'ın benzersiz izleme teknolojisi Insight Analitik ile filtreleme performansı üzerinde kontrol sahibi olun.
- Orta hava akışına sahip yenilikçi torba tasarımı sayesinde optimize edilmiş kapsama alanı
- Akıllı temizleme sistemi, uzun filtre ömrü ve optimize edilmiş kapsama alanı sayesinde daha düşük TCO
- Nesnelerin İnterneti için hazırlanmış Geleceğe yönelik sistemi - Insight Ready









Medya	MEP Ex Akıllı filtre
Kompresör hava tüketimi	58 litres per cleaning pulse at 5,5 bar compressed air
Kurulum	[Indoor], [Outdoor]
Materyal	2 mm galvanised sheet metal
Patlayıcı toz için ideal	True
Filtre temizlik metodu	[Pulsejet]
Application	[fumes], [dust]
Çalışma Basıncı (kPa)	Vacuum max. 6 kPa. Overpressure max. 0 Pa. (1,5 kPa for silotop solution)
Çöp kovası (l)	50 or 100 litre bin
Filtre alanı (m ²)	15 - 88
Kapasite(maks. Hava debisi m ³ /h)	1800 - 10500
Operating Temperature	-20°C to +70°C
Filtre türü	[casette]
Filtre materyali	



Fumes Dust







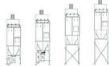

MEP Ex Akıllı filtre

MEP Ex Akıllı filtre

[image]	Bilgi Dökümanı ismi	Filtre adedi	[model]
	MEP-4-4-Ex Akıllı filtre	4	MEP-4-4-Ex
	MEP-6-4-Ex Akıllı filtre	6	MEP-6-4-Ex
	MEP-8-4-Ex Akıllı filtre	8	MEP-8-4-Ex
	MEP-2-6-Ex Akıllı filtre	2	MEP-2-6-Ex
	MEP-4-6-Ex Akıllı filtre	4	MEP-4-6-Ex
	MEP-6-6-Ex Akıllı filtre	6	MEP-6-6-Ex
	MEP-8-6-Ex Akıllı filtre	8	MEP-8-6-Ex
	MEP-2-4-Ex Akıllı filtre	2	MEP-2-4-Ex

MEP Ex Akıllı filtre

Accessories

Figure	Description	Figure	Description
	Top mounted FM-fans 50 Hz or 60 Hz up to 14000 m³/h		Leg height extensions from 0 mm to 2000 mm to fit larger bins/containers, rotary valves and big bags
	Combifab remote fans 50 Hz or 60 Hz		Leg width extension 300 mm to left, right or both sides to fit larger bins/containers, rotary valves and big bags
	Noise enclosure to reduce fan and motor break-out-noise of FM-fans		Suspension below rotary valve for big bag
	Dual silencer to reduce air flow, fan noise and motor break-out-noise of FM-fans (available with grid (indoor use), grid and rain cover (outdoor use) or flange for duct connection)		Isolation box for pressure tank incl. clearing valves
	Regulation (iris) damper at fan inlet for FM-fans		Access platform with ladder for maintenance
	Dust bins (50 l, 50 l with wheels and 100 l with wheels)		Lime feeder NFKG-70
	Plastic bag in the dust bin with pressure compensation set 'bin balancing'		Several sensors available for extraction, filtration and discharge process
	Rotary valves NRS3 and NRSZ3		Water separator and pressure regulator
	Dust discharge valve NFUS3		QF-duct system

Envelope material

- NF100 – Polyester needlefelt, singed, 500 g/m²
- NF130 – Polyester needlefelt, glazed, 500 g/m²
- NF141 – Polyester needlefelt, glazed, 400 g/m², antistatic
- NF142 – Polyester needlefelt, glazed, 500 g/m², antistatic
- NF143 – Polyester needlefelt, PTFE coating, 550 g/m², antistatic
- NF180 – Polyester needlefelt, glazed, 550 g/m²
- NF181 – Polyester needlefelt, PTFE coating, 550 g/m²

MCP Envelope material

MEP Ex Akıllı filtre

A – Height of Clean Air Chamber (mm)			
200	350	500	650
Shown in drawings	Add 150 mm in height	Add 300 mm in height	Add 450 mm in height

MEP A - height of clean air chamber

Product Marking of MEP SmartFilter Ex

  II 1D/3D/- c Ex h IIIC 120°C Da/Dc/-

MEP SmartFilter Ex marking

Pred.max	KST	Zone Placement
0,3 bar	S11 (0 to 200 bar m s ⁻¹) S12 (> 200 to 300 bar m s ⁻¹) S13 (> 300 bar m s ⁻¹)*	None-zone Zone 22*

*Not available as standard, available by request

MEP SmartFilter Ex specifications

Filter area

Filter type	Quantity of envelopes	Filter area (m ²)	Max. airflow (m ³ /h)*
MEP-2-4 MEP-2-4-Ex	2	15	1800
MEP-4-4 MEP-4-4-Ex	4	29	3400
MEP-6-4 MEP-6-4-Ex	6	44	5200
MEP-8-4 MEP-8-4-Ex	8	58	7000
MEP-2-6 MEP-2-6-Ex	2	22	2600
MEP-4-6 MEP-4-6-Ex	4	44	5200
MEP-6-6 MEP-6-6-Ex	6	66	8000
MEP-8-6 MEP-8-6-Ex	8	88	10500

*Max. air flow is dependent on the dust type, etc.

MEP Filter area

MEP Ex Akıllı filtre

MEP-2.4 / MEP-2.4-Ex
MEP-2.6 / MEP-2.6-Ex

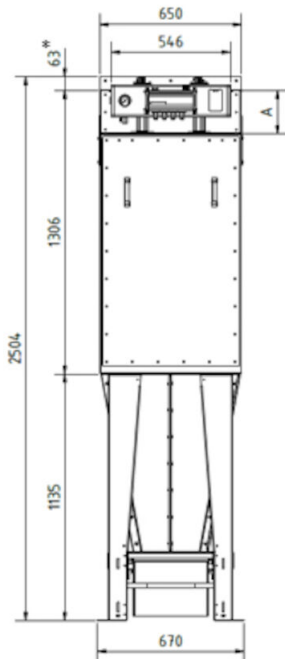

All dimensions in mm.

If 50 liter bin with wheels 90 mm must be added to the height.

* to be included only if a top mounted FM fan is used (transition for fan).

MEP Ex Akıllı filtre

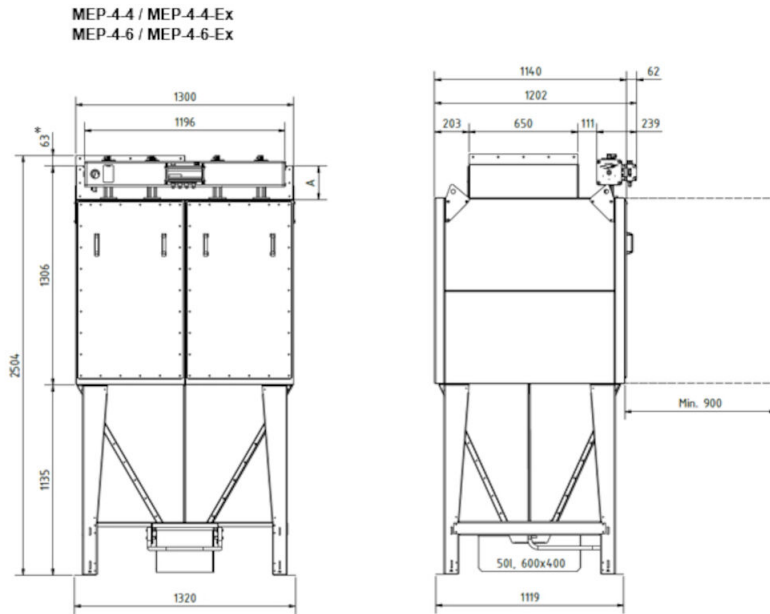

All dimensions in mm.

If 50 liter bin with wheels 90 mm must be added to the height.

* to be included only if a top mounted FM fan is used (transition for fan).

MEP Ex Akıllı filtre

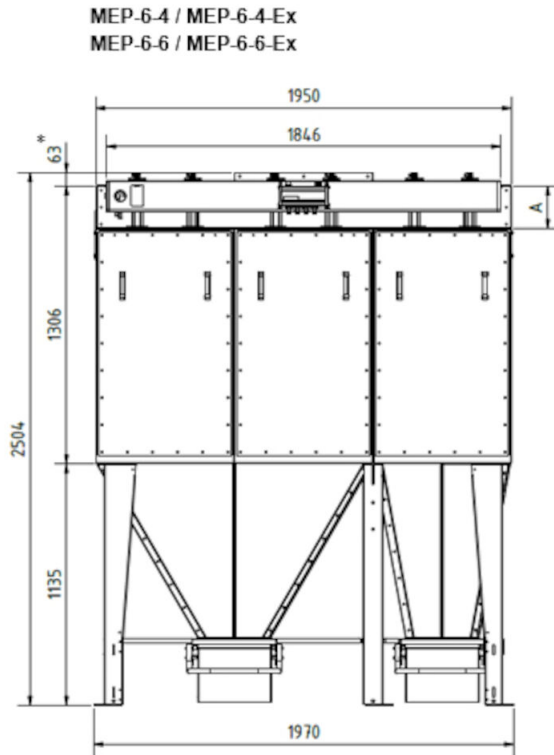

All dimensions in mm.

If 50 liter bin with wheels 90 mm must be added to the height.

* to be included only if a top mounted FM fan is used (transition for fan).

MEP Ex Akıllı filtre

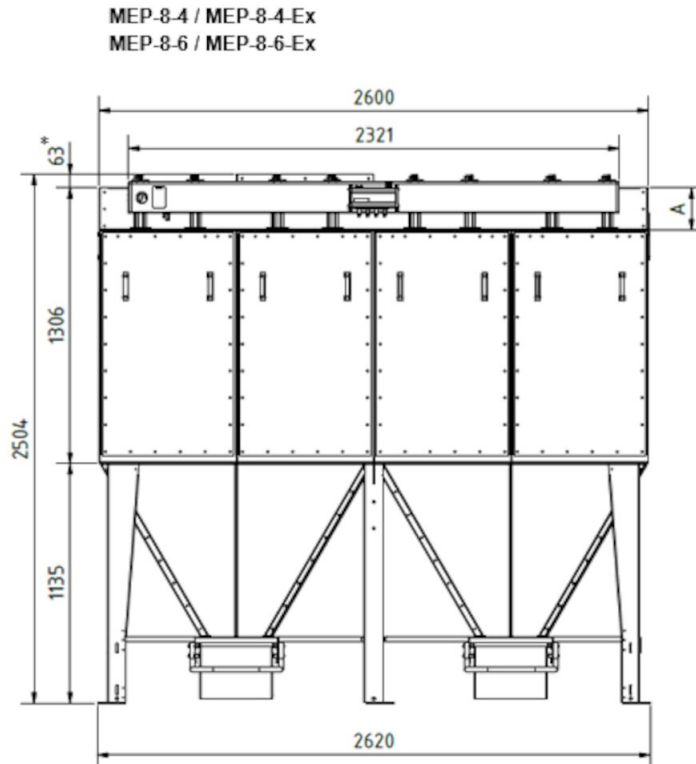

All dimensions in mm.

If 50 liter bin with wheels 90 mm must be added to the height.

* to be included only if a top mounted FM fan is used (transition for fan).