

# FilterBox 10A

Automatically cleaned for light to medium dust & fume applications.

---

## FilterBox 10A



When mobility, flexibility and a compact footprint is key, a mobile solution is often the best way to avoid contaminant exposure. Nederman FilterBox range of mobile dust and fume extraction units are easy to move around your factory to wherever the extraction is needed. The wide product range makes it easy to find a model with the capacity, features and filter type needed.

The FilterBox 10A is equipped with a N24 fan for a maximum air flow capacity of 1 000 m<sup>3</sup>/h (600 CFM) and is ideal for medium frequency dust or fume applications.

The unit has an advanced filter control system indicating the pressure drop with a series of LED's as well as on the LCD display. When the air flow is too low an aural alarm precedes the automatic, motorized compressed air cleaning sequence. For dust applications, the unit is cleaned mechanically. For welding fumes it uses a combination of mechanical and compressed air cleaning. An integrated silencer reduces noise from the fan and outlet air. Additional protection from harmful particles is provided if a HEPA filter is installed (optional).

FilterBox 10A is available as a mobile unit on wheels or a fixed mount unit.

Note! FilterBox is not for use in environments where combustible dust or gases are present, and it is not for use in filtering combustible dust or gases.

- Automatically operated, mechanical and pneumatic filter cleaning for long filter life.
- LCD panel with operating status and menu system for parameter setup and settings.
- Possibility to connect a welding sensor clamp to automatically start the fan.
- Automatic damper preventing dust from leaking out while cleaning.

- Dust free filter replacement and emptying of dust bin.
- Filter efficiency M6 (EN779), MERV 11 (ASHRAE 52.2, 2017).

Approved for welding fumes category W3 according to EN 15012-1, third party tested.







Product name	FilterBox 10A
Noise level (dB(A))	66
Protection class	IP 54
Filter efficiency (%)	99
Compressed air requirement	DIN ISO 8573-1, class 5/5/4 (7 bar)
Installation	Indoor
Material	Casing in rotomoulded plastic

# FilterBox 10A



Dustbin volume (l)	15
Extraction arm diameter (mm)	160
Airflow (m <sup>3</sup> /h)	1000
Filter Area (m <sup>2</sup> )	13
Filter type	Cartridge
Number of filter elements	1
Filter material	Polyester PW13
Electric plug	Without
Filter cleaning method	Mechanical, Compressed air
Note	













# FilterBox 10A

Image	Description	Arm length (m)	Power Voltage (V)	Frequency (Hz)	No of phases	Mounting	Weight (kg)	Power (kW)	Filter Area (m <sup>2</sup> )	Model
	FilterBox 10 A	3	200	50	3	Mobile	102	0,9		12679163
	FilterBox 10 A	3	200	50	3	Floor mounted	99	0,9		12679263
	FilterBox 10 A	3	230	50	3	Mobile	102	0,9		12655263
	FilterBox 10 A	3	230	50	3	Floor mounted	99	0,9		12655363
	FilterBox 10 A	3	400	50	3	Mobile	102	0,9	13	12655463
	FilterBox 10 A	3	400	50	3	Floor mounted	99	0,9		12655563
	FilterBox 10 A	3	230	50	1	Mobile	102	0,75		12655663
	FilterBox 10 A	3	230	50	1	Floor mounted	99	0,75		12655763
	FilterBox 10 A	3	110	50	1	Mobile	102	0,75		12655863
	FilterBox 10 A	3	110	50	1	Floor mounted	99	0,75		12655963
	FilterBox 10 A	3	230	60	3	Mobile	102	0,9		12657863
	FilterBox 10 A	3	200	60	3	Mobile	102	0,9		12658463
	FilterBox 10 A	3	200	60	3	Floor mounted	99	0,9		12658563
	FilterBox 10 A	3	120	60	1	Mobile	102	0,75		12658663
	FilterBox 10 A	3	120	60	1	Floor mounted	99	0,75		12658763

## FilterBox 10A

Image	Description	Arm length (m)	Power Voltage (V)	Frequency (Hz)	No of phases	Mounting	Weight (kg)	Power (kW)	Filter Area (m <sup>2</sup> )	Model
	FilterBox 10 A	Without	400	50	3	Floor mounted	99	0,9		12685063
	FilterBox 10 A	Without	400	50	3	Mobile	102	0,9		12686763
	FilterBox 10 A	3	380	60	3	Mobile	102	0,75		12689263

## FilterBox 10A

Accessory		Part No
	Outlet with duct connection D=200mm	12376749
	Spotlight original, (LED) 24V, 5W	12376616*
	Spark protection for Original/NEX MD-hood	10551335
	LED light/fan switch Original	10376922
	Filter-PW-FB-13	12332672
	Filter-PW HE-FB-15	12371106
	Filter PWA-FB-15	12371412
	HEPA filter H13 10m2 Filterbox	12376615
	Bags for Filterbox dust bin, 10pcs	12376618
	HEPA filter H14 10m2 Filterbox	12376756
	Sensor Clamp	14372199
	Twin Module blue	12376801
	Filter NANO-FB-17	12377251
	Filter PTFE-FB-13	12377252

\*Switch for light (no fan start)

## FilterBox 10A

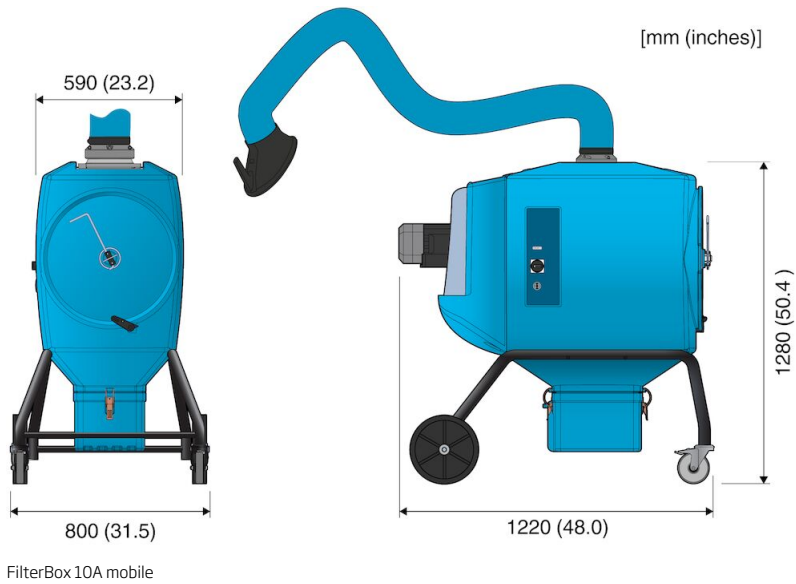

FilterBox 10A mobile

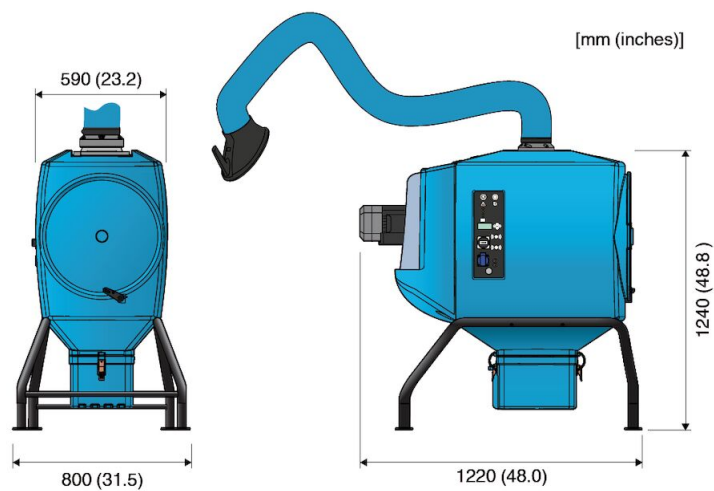

Floor mounted FilterBox 10A

FilterBox 10A Floor