

NOM 18

Olietågefilter



Beregnet til maskiner som stanser og presser stålplade, til industrivaskemaskiner, til abrasiv vandskæring, til anvendelse i bagerier etc. Ved al metalbearbejdning og andre processer problematisk olietåge kan disse filtre monteres i et rørsystem som er tilsluttet maskinerne. Alle enheder er udstyret med trykmanometer for kontrol af filtret, samt en indikator for hvornår filtret skal rengøres (selvdrænende). Passer til emulsioner såvel som til rene syntetiske/mineralske olier.

- Lave vedligeholdelsesomkostninger
- Selvdrænende olietågefilter
- Enkel installation
- Overlegen udskilningsgrad
- Optager lidt plads med integreret ventilator for de fleste modeller

Produkt navn	NOM 18
Lydniveau (dB(A))	63,8
Beskyttelsesklasse	IP 55
Filter udskilningsgrad (%)	97,5
Tryklufthsbehov	Nej
Tryklufthsforbrug	Nej
Installation	Indendørs
Materiale	Hus i pulverlakeret metalplade.
Egnet til eksplosivt støv	False
Genvinding (%)	90
Filterareal (m ²)	14
Kapacitet (max luftvolumen m ³ /h)	1800
Driftstemperatur	5 - 60 °C
Type af filter	Filterpatron
Antal filter	2
Effekt (kW)	1,1



NOM 18

Beskrivelse	Spænding (V)	Frekvens (Hz)	Faser	Filtermateriale	Strøm (A)	Vægt (kg)	Model
NOM 18	230	50	1	Glassfibre/Polyester	6,7	205	12631968
NOM 18 HEPA	230	50	1	Glasfiber/polyester	6,7	215	12632068*
NOM 18	400/230	50	3	Glasfiber/polyester	2,45/4,3	205	12632368
NOM 18 HEPA	400/230	50	3	Glasfiber/polyester	1,45/4,3	215	12632468*
NOM 18 (uden ventilator)				Glasfiber/polyester		188	12632768**
NOM 18 HEPA (uden ventilator)				Glasfiber/polyester		198	12632868***
NOM 18 HEPA	220	60	1	Glasfiber/polyester	2,37	215	12634268****
NOM 18	220	60	3	Glasfiber/polyester	2,37	205	12634168
NOM 18	380	60	1	Glasfiber/polyester	2,37	205	12634068









*Inkluderer HEPA filter med 24 m² filterareal og 99,97% effektivitet.

**Leveret uden ventilator

***Inkluderer HEPA filter med 24 m² filterareal og 99,97% effektivitet. Leveret uden ventilator.

****Includes HEPA filter with 24 sqm filterarea and with 99,97 % efficiency.

NOM 18

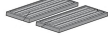
Tilbehør		Artikelnummer
	FMS 1.6-2.5 Fan Manual Starter incl. motor protector 1.6-2.5A	14502237
	FMS 6.3-10 Fan Manual Starter incl. Motorprotector 6.3-10A	14502537
	Silencer NOM 18, 28	12373650
	Container NOM 11, 18, 28	12373651
	Slange med olieudskiller NOM	12373652
	Filterdæksel for NOM filter	12376746
	FMS 2.5-4 Fan Manual Starter incl. motor protector 2.5-4A	14502337
	HEPA filter NOM 18 (replacement)	12373647
	Hovedfilter NOM 18 (udskiftning)	12373655
	Grov forfilter	12376294

NOM 18

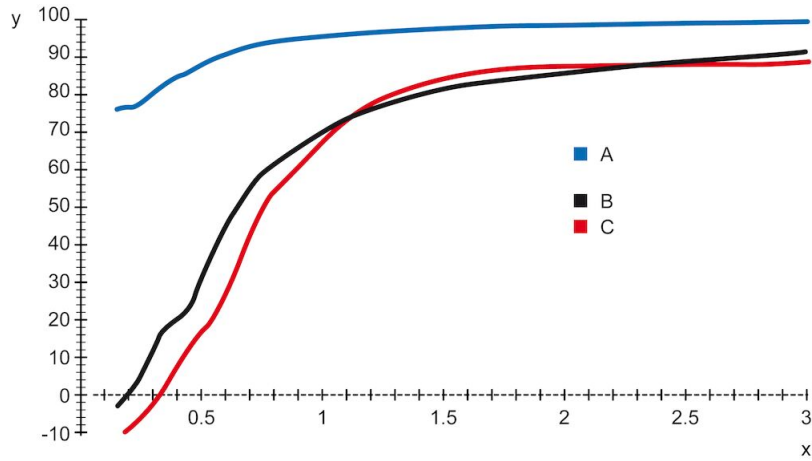

Y = Efficiency (%), X = Particle size (µm)

A = NOM filter, B = Centrifugal filter A, C = Centrifugal filter B

Efficiency of NOM main filter compared to typical centrifugal filters, tested with DOP.

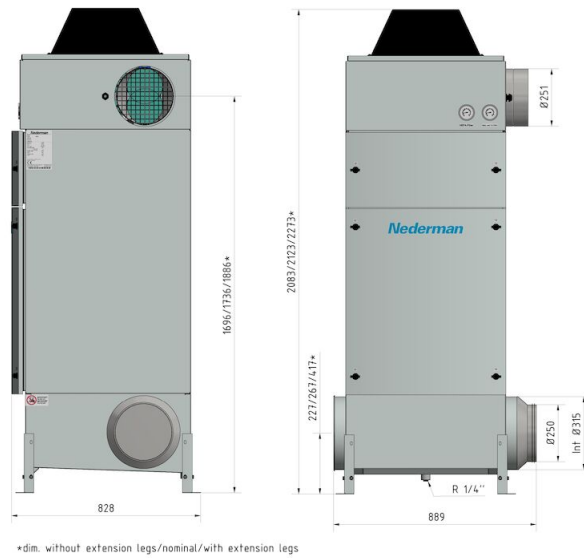

NOM 18

