

NOM 18

Oil mist filter



Designed for lathing and milling applications, for machines stamping and pressing steel plates, industrial washing machines, abrasive water jets etc. In all metal fabrication with oil mist troubles, these filters will fit into a ducting system, connected to each machine. All units are equipped with pressure gauge for control of filters as well as an indication for need of cleaning (self draining). Suitable for emulsion mist.

- Low maintenance cost
- Self draining mist filter
- Easy to install
- High filtration efficiency
- Made to take up very little space with integrated fan for most models

| | |
|--|--|
| Product name | NOM 18 |
| Noise level (dB(A)) | 63,8 |
| Protection class | IP 55 |
| Filter efficiency (%) | 97,5 |
| Compressed air requirement | No |
| Compressed air consumption | No |
| Installation | Indoor |
| Material | Housing made in oil resistant wet painted sheet metal. |
| Suitable for combustible dust | False |
| Material recycling (% weight) | 90 |
| Filter Area (m ²) | 14 |
| Capacity (max airflow m ³ /h) | 1800 |
| Operating Temperature | 5 - 60 C |
| Filter type | Cartridge |
| Number of filter elements | 2 |
| Filter material | Glassfibre/Polyester |
| Power (kW) | 1,1 |



NOM 18

| Description | Power Voltage (V) | Frequency (Hz) | No of phases | Amperage (A) | Weight (kg) | Model |
|--------------------------------------|-------------------|----------------|--------------|--------------|-------------|--------------|
| NOM 18 | 230 | 50 | 1 | 6,7 | 205 | 12631968 |
| NOM 18 HEPA | 230 | 50 | 1 | 6,7 | 215 | 12632068* |
| NOM 18 | 400/230 | 50 | 3 | 2,45/4,3 | 205 | 12632368 |
| NOM 18 HEPA | 400/230 | 50 | 3 | 1,45/4,3 | 215 | 12632468* |
| NOM 18 (without fan) | | | | | 188 | 12632768** |
| NOM 18 HEPA (without fan) | | | | | 198 | 12632868*** |
| NOM 18 HEPA | 220 | 60 | 1 | 2,37 | 215 | 12634268* |
| NOM 18 | 220 | 60 | 3 | 2,37 | 205 | 12634168 |
| NOM 18 | 380 | 60 | 1 | 2,37 | 205 | 12634068 |
| NOM 18 | 115/230 | 60 | 1 | 13,6/6,8 | 205 | 12632168 |
| NOM 18 HEPA | 115/230 | 60 | 1 | 13,6/6,8 | 215 | 12632268* |
| NOM 18 | 230/460 | 60 | 3 | 3,7/1,8 | 205 | 12632568 |
| NOM 18 HEPA | 230/460 | 60 | 3 | 1,5 | 215 | 12632668* |
| NOM 18 | 575 | 60 | 3 | 1,5 | 205 | 12632968 |
| NOM 18 HEPA | 575 | 60 | 3 | 1,5 | 215 | 12633068* |
| NOM 18 HEPA (with fan without motor) | | 60 | | | 205 | 12633168**** |









*Includes HEPA filter with 24 sqm filterarea and with 99,97 % efficiency.

**Delivered without Fan

***Delivered without Fan. Includes HEPA filter with 24 sqm filterarea and with 99,97 % efficiency.

****Delivered with fan but without motor. Includes HEPA filter with 160 sqm filterarea and with 99,97 % efficiency.

NOM 18

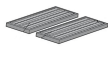
| | Accessory | Part No |
|---|---|----------|
|  | FMS 1.6-2.5 Fan Manual Starter incl. motor protector 1.6-2.5A | 14502237 |
|  | FMS 6.3-10 Fan Manual Starter incl. Motorprotector 6.3-10A | 14502537 |
|  | Silencer NOM 18, 28 | 12373650 |
|  | Container NOM 11, 18, 28 | 12373651 |
|  | Hose with oil trap NOM | 12373652 |
| | Filter cover for NOM filter | 12376746 |
|  | FMS 2.5-4 Fan Manual Starter incl. motor protector 2.5-4A | 14502337 |
|  | HEPA filter NOM 18 (replacement) | 12373647 |
|  | Mainfilter NOM 18 (replacement) | 12373655 |
|  | Coarse pre-filter | 12376294 |

NOM 18

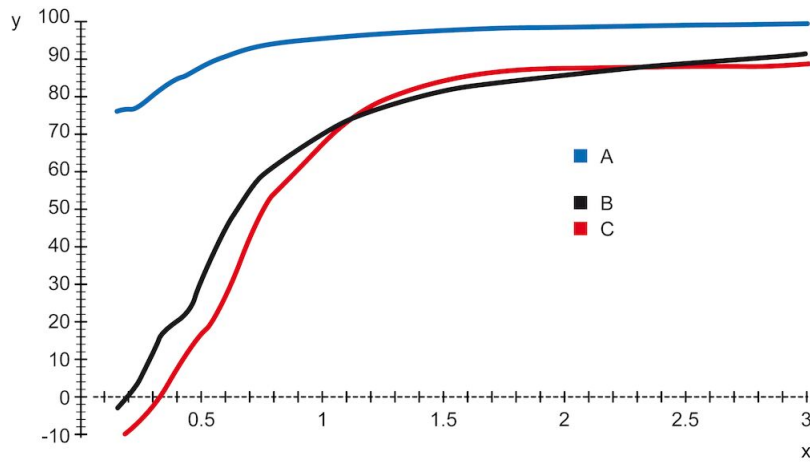

Y = Efficiency (%), X = Particle size (µm)

A = NOM filter, B = Centrifugal filter A, C = Centrifugal filter B

Efficiency of NOM main filter compared to typical centrifugal filters, tested with DOP.

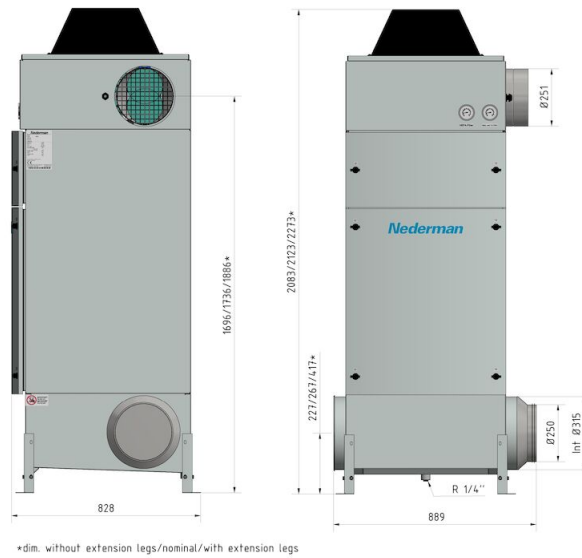

*dim. without extension legs/nominal/with extension legs

NOM 18

